

Building A 3-Way Turnout Using A Fast Tracks Assembly Fixture & QuickSticks Laser Cut Wood Ties

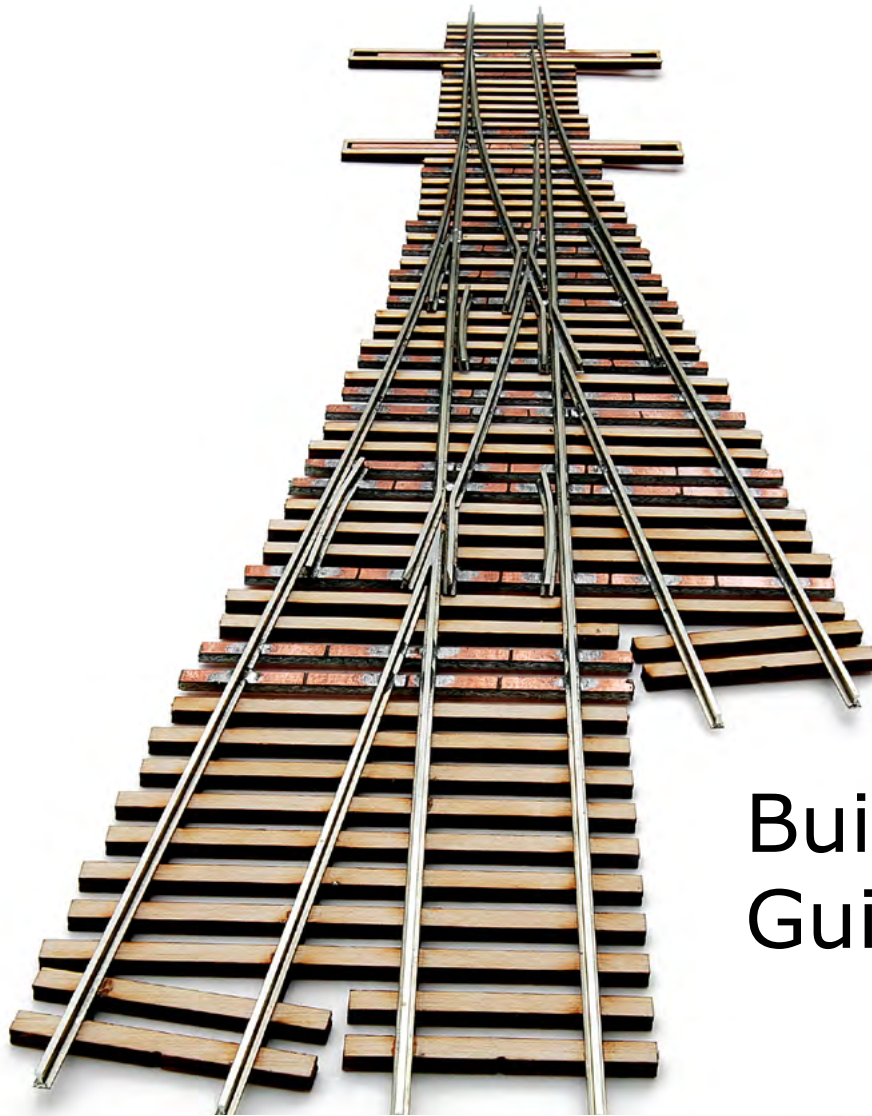

Builders'
Guide



Since 2003

Fast Tracks Users' Guide UG06

The latest version of this Builders' Guide is always available for download from the Fast Tracks website at: www.handlaidtrack.com/documents

This document has been designed to be printed on both sides of the paper and bound using spiral or cerlox binding.

This document may be freely reproduced as long as it is printed or electronically duplicated in its entirety without modification and is not made part of another document.

Written & Published by

Fast Tracks Hobbyworks Inc.
312-B St. Patrick St.
Port Dover, Ontario N0A 1N0
Canada

Email: service@fast-tracks.net
Phone: 1-888-252-3895
Web: www.fast-tracks.net

This document was last updated on October 12, 2015

All content & images are copyright © 2015 Fast Tracks Hobbyworks Inc., All rights reserved.

DISCLAIMER: While we have made every effort to ensure that this users' guide is accurate, we cannot guarantee it to be 100% free from errors or inaccuracies. FAST TRACKS HOBBYWORKS INC., NOR ANY OF THEIR EMPLOYEES SHALL NOT BE LIABLE FOR ANY DAMAGES INCLUDING, BUT NOT LIMITED TO, DIRECT, INDIRECT, SPECIAL, INCIDENTAL OR CONSEQUENTIAL DAMAGES OR OTHER LOSSES ARISING OUT OF THE USE OF OR INABILITY TO USE ANY FAST TRACKS PRODUCT.

Thank You For Buying Fast Tracks Products!

Fast Tracks was born out of my frustration with building accurate and reliable turnouts by hand. I just felt that there had to be a better way. So after a lot of experimenting and trial and error I came up with a solution that worked so well, that I decided to offer track assembly fixtures for sale to other model railroaders.

I have spent a lot of time 'sweating the details' and have worked hard to produce the highest quality product possible. If you are not 100% satisfied with your Fast Tracks product, or are not getting the results that you expected, then please contact me directly at service@fast-tracks.net and I will try and help you out, or arrange to refund your money.

If you are happy with your Fast Tracks product, then please tell your friends! Despite our hyper-linked and over-connected society, I still rely mostly on satisfied customers and word of mouth to promote my products.

You will always find the latest version of these instructions on the Fast Tracks website at www.handlaidtrack.com/documents. I would suggest that you bookmark this address in your browser so that if you ever misplace or wear out these instructions you will be able to download another copy from our website.

We also maintain an online discussion forum about Fast Tracks products on our website at www.handlaidtrack.com/forums. There you will find a host of information & advice from myself and other customers. Why not drop by and tell us how you are making out with your hand laid track project?

Also, [Fast Tracks is on Facebook!](#) If you are a Facebook user, join our Fast Tracks page as I frequently update it with what is going on here during the day.

Again, thank you for your purchase. And please do not hesitate to contact me if you have any questions or problems with your product. I will do my best to reply within one business day.

Tim Warris & the staff of Fast Tracks
service@fast-tracks.net
www.fast-track.net



Craftsman Series Product

3-Way switch assembly fixtures are part of our Craftsman Series of tools and are only recommended for experienced modelers with advanced track building skills. This document assumes that the craftsman is familiar with basic track terminology and has mastered basic construction techniques and soldering skills.

If you are new to hand laid trackwork we would suggest that you start with simpler switches such as turnouts or wyes. Once you have mastered building this type of trackwork then you will be ready to take the next step and start building more complex switches.

The techniques required to build trackwork using Craftsman Series tools and supplies are not really any different than simpler switches - however the complex geometry of 3-Ways can make it more challenging to get great results.



Building a 3-Way Turnout in a Fast Tracks Assembly Fixture

This document details the construction of a 3-Way turnout switch using a Fast Tracks assembly fixture and QuickSticks laser cut wood ties. Building a 3-Way turnout isn't all that different than building a standard turnout, however the geometry of a 3-Way does require two additional frogs - one additional standard frog and a third frog that is commonly referred to as a "sub-frog", Sub-frogs are built in the same way as standard frogs, the only difference is that the angle of the points is quite a bit larger. To accommodate this larger angle, a special 3-Way PointForm tool is available (and highly recommended) with an additional groove for forming sub-frogs.

As the point rails in a 3-way switch are very short and cannot flex as freely as they do in a standard turnout, it is necessary to use hinged switchpoints. The extra steps required to build hinged points are detailed in this document.

There are 14 parts to building a 3-Way switch including:

1. Form the Guard Rails
2. Pre-Build the Frog Points
3. Place Pre-Gapped PC Board Ties into the Assembly Fixture
4. Form and Install the Stock Rails
5. Form and Install the Closure/Switch Point Rails
6. Install the Pre-Built Frogs
7. Install the Pre-Formed Guard Rails
8. Re-Enforce the Frog Points
9. Cut Off the Switch Points
10. Form and Install the Rail Joiner Hinges
11. Solder the Switch Points to the Throw Bars
12. Cut the Frog Isolation Gaps
13. Clean the Completed Turnout Skeleton
14. Glue QuickSticks Laser Cut Ties to the Complete Trackwork (Optional)

We will cover each of these parts in detail. You should plan to spend approximately 4-5 hours over a couple of evenings building your first switch. With practice you should be able to get construction time down to as little as a couple of hours.

In addition to the images provided with each construction step, we have also generated an appendix of geometry drawings that clearly identifies each rail that makes up a standard 3-Way switch. You may want to print out these drawings separately as we will be referring to them quite often throughout this document. You will find these drawings at the end of this document.

Tools & Supplies That You Will Need



1. Your Fast Tracks 3-Way Assembly Fixture (A standard turnout fixture is shown in the above image.)
2. A new, sharp 10" Mill 2nd Cut file (Use your old files for stirring paint!)
3. A small triangle needle file
4. A small brush
5. Acid flux paste
6. Small diameter solder (.015 to .020 diameter solder is preferred and shown in the image above.)
7. A Weller WP35 watt iron with ST7 tip
8. Xuron rail cutters
9. PC board ties
10. A sharp point marker (or scriber)
11. A copy of the tie template for your particular switch. (Not shown) You can download the most recent version of the template from our web-site at www.handlaidtrack.com/tie-templates.php

Additional Items You will Need to Build a 3-Way Turnout

In addition to the standard tools for you will also need to the following items to build a 3-Way turnout:

1. NMRA Track Gauge
2. Jewelers Saw and spare blades
3. Matching rail joiners (for the hinged points)
4. 3-Way PointForm tool (Highly recommended)
5. Bench top sander
6. Brightly lit work area
7. Comfortable pants, or no pants at all
8. Patience!

Soldering Techniques

We highly recommend that you carefully review and practice the soldering techniques detailed in our **Soldering Techniques** document (AN01) and/or **How To Solder Trackwork** video before you begin. You will find this document and video on the CD that was included with your order or on our website at www.handlaidtrack.com/documents.

Weathered Rail Warning!

We do not recommend the use of weathered rail for building trackwork using the Fast Tracks Assembly Fixtures. The weathering effect that is applied to the rail makes it very difficult to solder the PC Board ties to the rail. If you have a stock of weathered rail on hand, we suggest you use it for other areas of you layout and purchase non-weathered rail for building turnouts.

Related Documents

The following documents are referred to in this document and will be needed during construction. You may want to print out copies of them now.

These documents will be included on the documentation CD that you received with your fixture, or you can download the latest version from our website.

- **Using The Fast Tracks PointForm Tool** - www.handlaidtrack.com/documents/ug10.pdf
- **Using Fast Tracks PC Board Ties** - www.handlaidtrack.com/documents/ug09.pdf
- **Developing Good Soldering Techniques** - www.handlaidtrack.com/documents/an01.pdf

Form The Guard Rails

There are two different lengths of guard rails used in a 3-Way turnout. Four short ones (identified as guard rails **A** & **B** on Appendix Drawing 3), and one long one. (Guard rail **C**) We will start by forming the A & C guard rails.

Image 1

Step 1

Starting with the short guard rails, insert a length of rail into the short guard rail groove located at one end of the assembly fixture and cut it to length as shown in image 1.

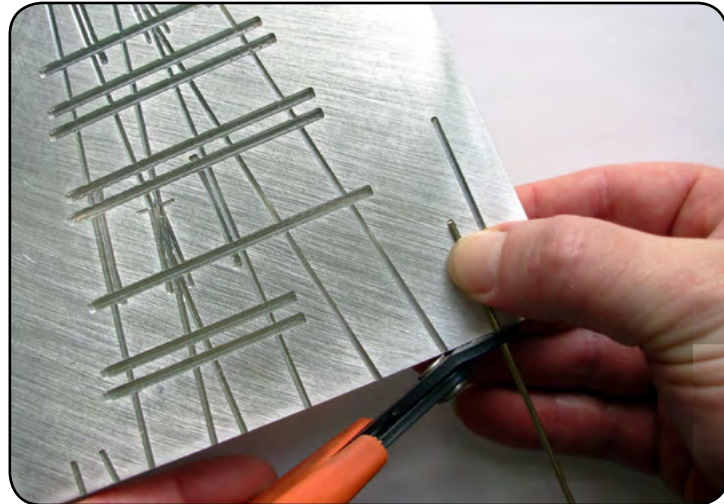

Step 2

Insert the rail you just cut into one of the short flare bending grooves and bend the rail perpendicular with the end of the fixture as shown in image 2. Repeat on the other end of the guard rail using the other bending groove.

Image 2

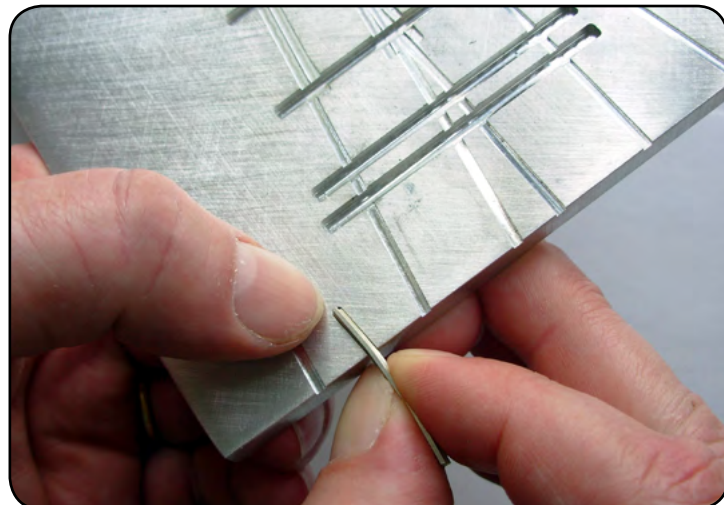

Step 3

Form two more short guard rails by repeating steps 1 & 2. (We will form the B guard rail a bit later on.)

Step 4

Create the long guard rail (C) by inserting a length of rail into the longest guard rail groove cutting it to length.

Image 3

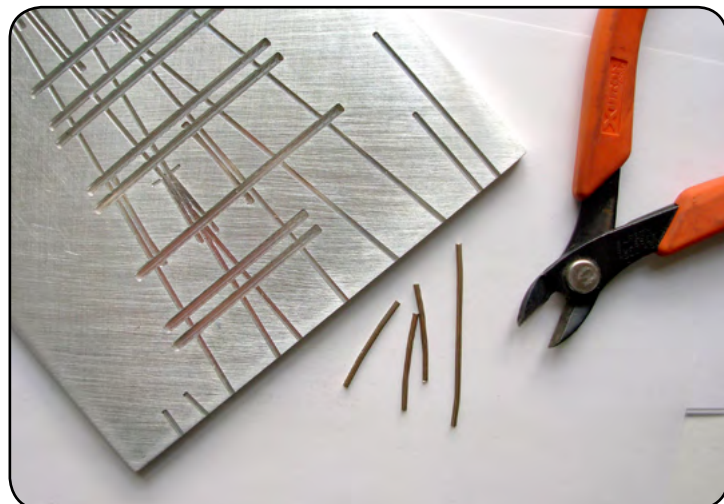

Step 5

Add the flares to the long guard rail by using the same flare bending grooves as before.

Step 6

Set all of the guard rails aside for now. We will install them a bit

later on in the build.

Pre-Build the Frog Points

There are three sets of frog points in a 3-Way turnout. Two of these are standard #6 frog points and are labeled Frog 1 and Frog 2 on Appendix Drawing 4. The third frog is about a #3 and is labeled as a "sub-frog" on Appendix Drawing 5. We will start by forming the two standard frog points. **Image 4**

Step 1

Cut two lengths of rail to form the frog point. If you are using Fast Tracks laser cut QuickSticks, set these under the fixture to ensure that the ends of the rails extend about an inch past the ties. (Image 4)

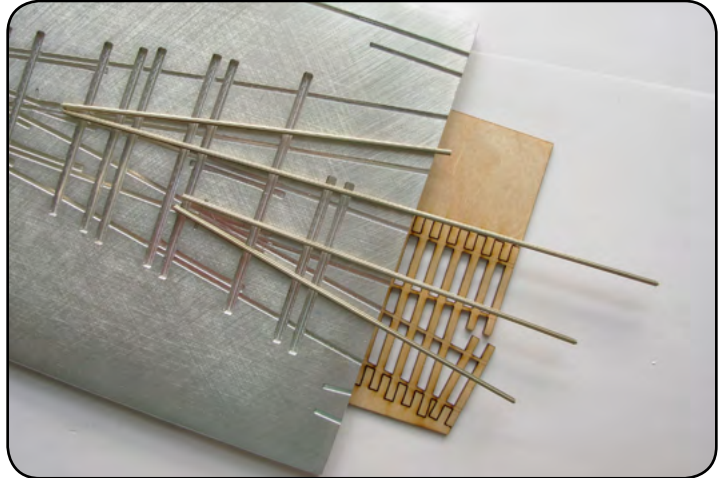

Step 2

Using the 3-Way PointForm tool, file the points onto one end of the rails. See the "Using Fast Tracks Point Form Tool" users' guide for complete instructions on how to use the PointForm tool to file the frog points.

You can also form the points by hand, but using the PointForm tool will make the job quick, simple and very accurate. (Image 5)



Step 3

Place the two halves of the frog points into the fixture. The two rails should meet to form a long, sharp point.

Be sure not to push the rails too far ahead in the grooves as this will cause them to "roll over". Just slide them forward until the two halves meet.

Apply flux to the top of the rails. (Image 6)

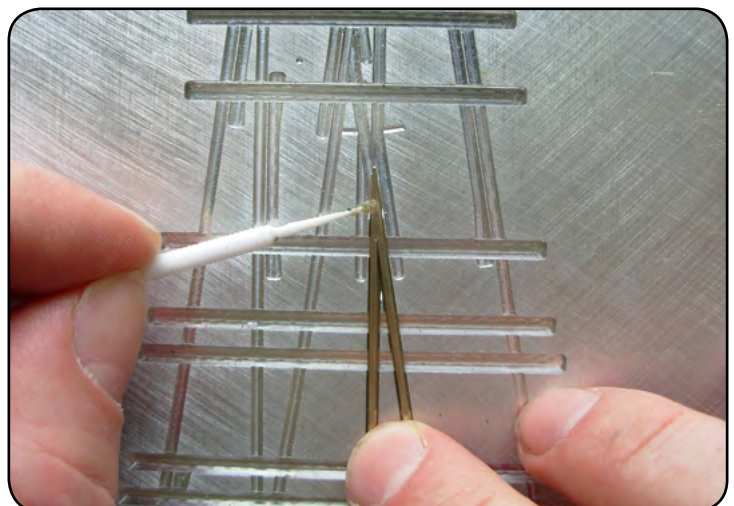

Step 4

When you solder the points, let the iron sit on top of the rails for a few seconds to ensure the solder has had a chance to 'sweat' in between the two halves of the frog. This will form a solid, strong solder joint. (Image 7) Be sure that the rails are sitting flat on the bottom of the rail grooves when the solder freezes.

Image 7

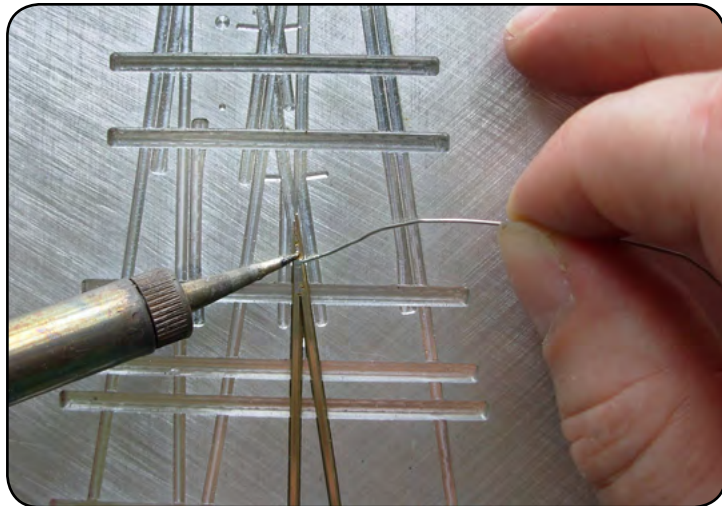

Step 5

Remove the completed frog point from the fixture and carefully file the top of the rail to remove any excess solder. A few light passes with a large file will clean it off. Don't be too aggressive with this step as it is possible to deeply scratch the head of the rail. (Image 8)

Image 8

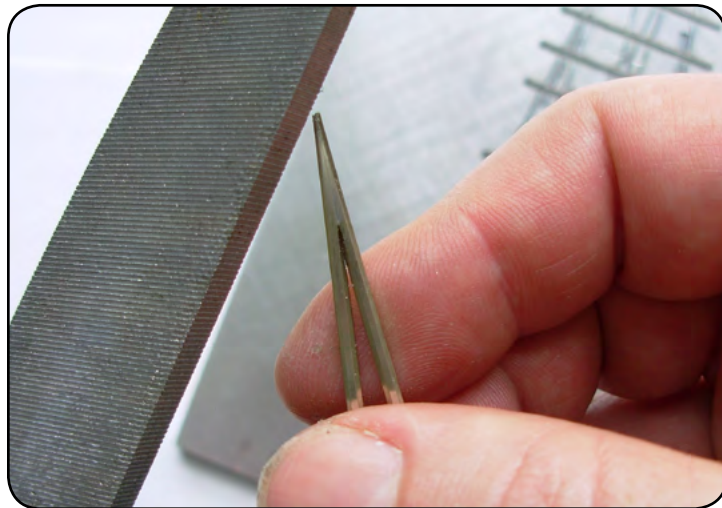

Step 6

Repeat steps 1 to 5 to form the second frog point and set them aside for now.

Image 9

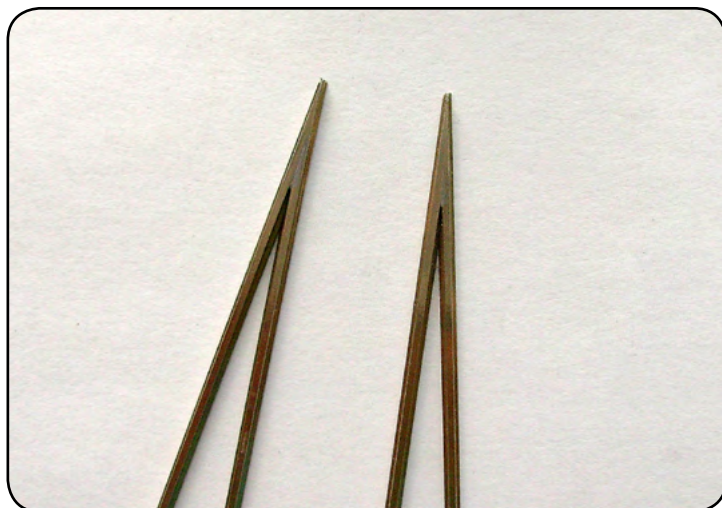

Step 7

The sub-frog is built using the same steps that were used for the standard frogs. The only difference is the angle of the points. If you are using the 3-Way Point-Form tool, insert the rail into the end labeled "Sub Frog" to file the sub-frog points to the correct angle.

Be sure to cut the rails for the sub-frog long enough to form the entire frog assembly. Refer to appendix drawing 5 to determine how long you need to make the rails for the sub-frog.

Image 10



Step 8

Solder and file the sub-frog using the same methods detailed in steps 3 to 5. Remove the sub-frog from the fixture and set it aside for now.

Image 11

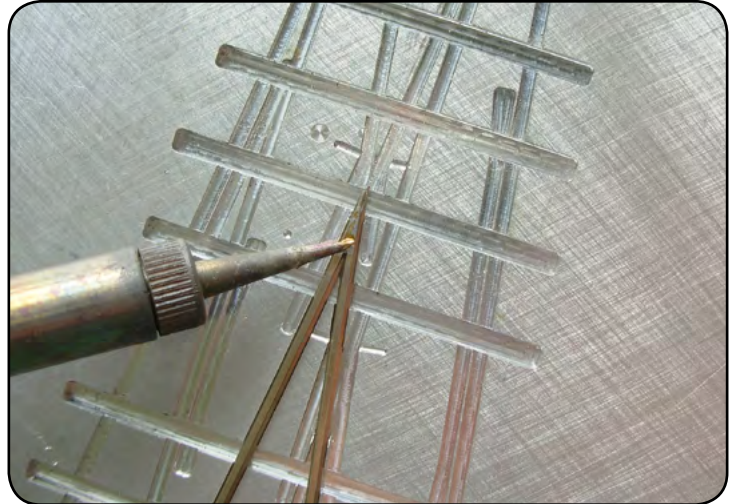
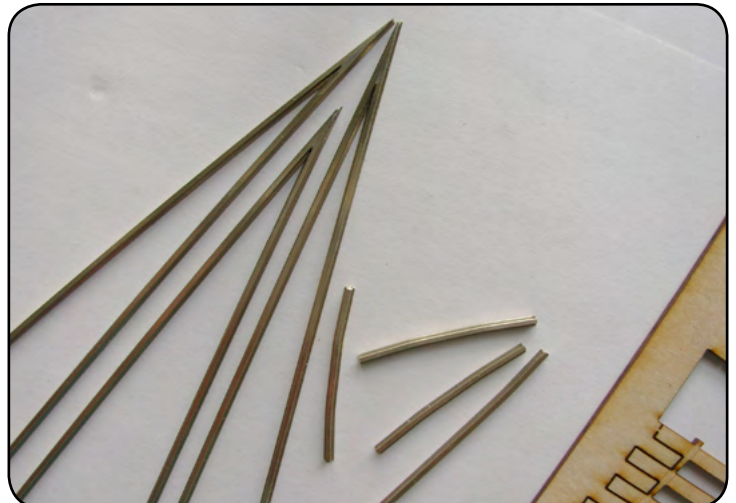

Image 12



Place Pre-Gapped PC Board Ties Into the Assembly Fixture

Image 13

Step 1

Using the printable tie template and fixture as a guide, cut the PC board ties to length - rail cutters work well for this.

Carefully file the isolation grooves into the surface of the PC board tie. This step is critical to prevent shorts and ensure an electrically reliable turnout. The location of PC board gaps is shown on the track templates. (Highlighted in red in image 13)

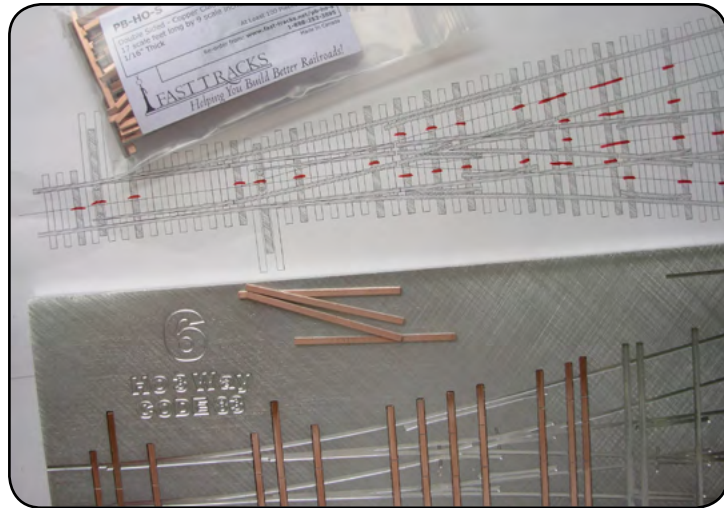

Image 14

For complete details on how to prepare, cut and gap PC Board ties, see our document titled "Using Fast Tracks PC Board Ties". (UG09) This document is on the CD that came with your order, or you can download it directly from our website at <http://www.han-dlaidtrack.com/v/vspfiles/documents/ug09.pdf>.



Step 2

There are three ties near the top of the turnout that are wider than standard length PC board ties. To span this length we will place two ties into the tie pockets and join them under the rail, this way they will be securely soldered together and no joint will be visible. (Image 14)

Confirm that the gapping is correct before proceeding onto the next part.

Warning!



It is very important that you ensure that the isolation gaps are cleanly cut and that there is no conductivity between the two halves of the tie.

Failure to ensure complete isolation can result in an electrical short, which can cause equipment problems, overheating and the risk of fire.

We recommend that you confirm that the two halves of the tie are electrically isolated by testing with a continuity tester. There should be no conductivity between the two halves of the tie if the gap has been properly cut.

Form and Install the Stock Rails

Step 1

Measure and cut a length of rail for the left stock rail. (See Appendix Drawing 2) If you are using QuickSticks laser cut ties, align these beside the fixture to help determine the length of rail to cut. Ensure that there is at least 1" of rail extending past the last tie in the turnout.

Image 15



Step 2

A section of the stock rail base needs to be removed to provide clearance for the straight route closure rail switchpoints.

To mark the base that needs to be removed, place the rail into the fixture and mark the area shown with the arrows in image 16.

Image 16

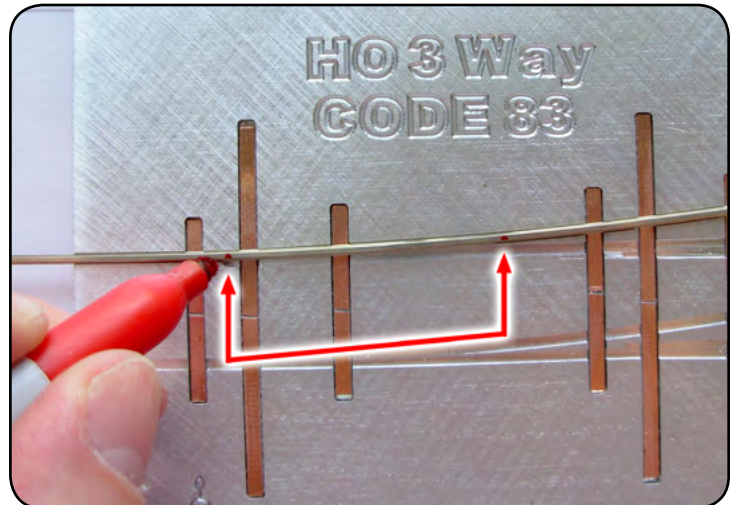

Step 3

There are a number of techniques for removing the base of the stock rail, but the easiest and most accurate method is to use our StockAid filing tool.

For more in-depth information, refer to our **Filing The Stock Rail With The Fast Tracks StockAid Tool document (UG18)**, or you can watch our **How To Use The StockAid Tool To File The Stock Rail** video. This video is included on the DVD that you received with your Assembly Fixture, or you can watch the video on our website at: www.handlaidtrack.com/videos.

Image 17



As you sand or file the base of the rail, taper the end opposite to the switchpoint as shown in image 18. The switchpoint end of the base cutout is cut square. (More detail about this step can be found in the StockAid tool documentation)

Image 18

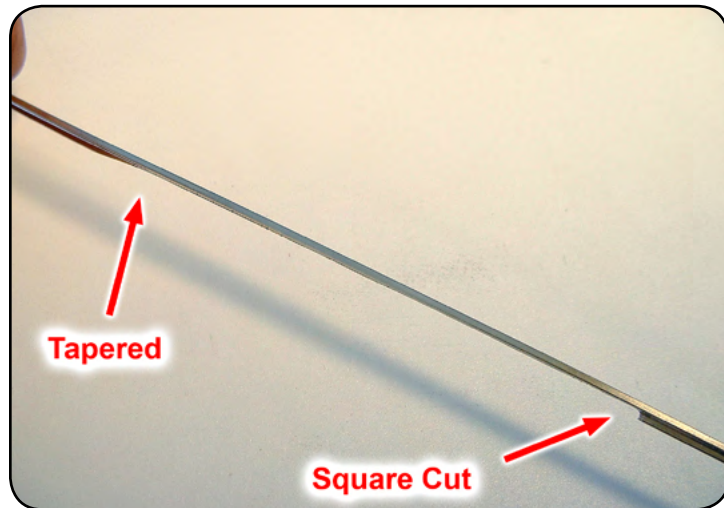

Step 4

Gently form the rail to approximately match the shape of the groove in the fixture where this rail is to be placed.

Notice that there is a slight “kink” where the switch points meet the stock rail shown with the arrow in image 19. Use the fixture to help you shape of the rail.

Image 19

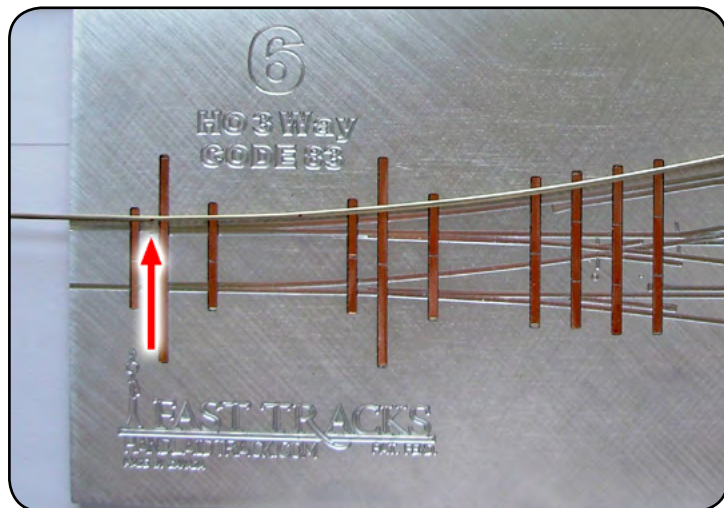

Step 5

Apply a small amount of flux (image 20) to a PC Board tie near the middle of the turnout, ensure that there is some flux on the base of the rail as well.

It is easiest to flux and solder the rail to one tie before fluxing and solder the remaining ties. This will hold the rail in place while you solder the remaining ties.

Image 20

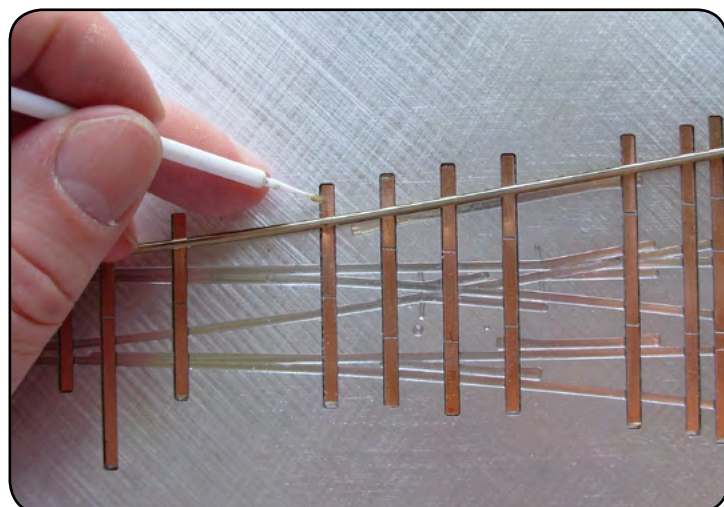

Step 6

Solder the rail to the tie that you just fluxed. (Image 21) Notice in the image that the iron is being held on the opposite side of the rail from the solder. Holding the iron on the base of the rail opposite to the side you are soldering for a few seconds will allow the solder to “wick” under the rail, forming a good joint.

If you are new to soldering, you may want to check out our “How To Solder Trackwork” video. A copy will be on the CD that came with your fixture, or you can watch the video online at www.handlaidtrack.com/videos

Step 7

Now flux and solder the rail to the remaining PC Board ties at the points shown by the arrows in image 22.

Step 8

Repeat steps 1 to 4 for right stock rail to remove the base of the rail for the left diverging route closure rail switchpoint.

Step 9

In addition to removing the base of the rail for the left diverging route closure rail switchpoint, you also need to remove the base of the right stock rail for the straight route closure rail switchpoint as shown in image 23.

Mark the rail as shown in image 23 and using the same methods as detailed in step 3, remove the base of the rail.

Image 21

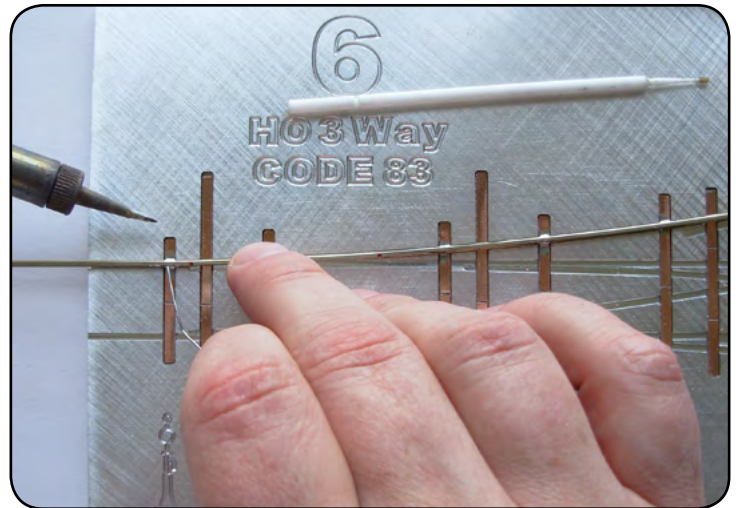
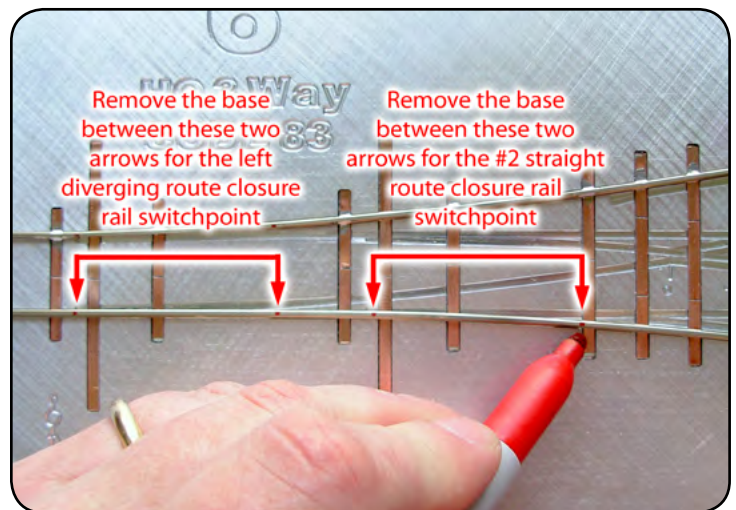

Image 22



Image 23



Step 10

Using the same methods as detailed in steps 4 to 7, solder the rail to the PC Board ties at the points shown in image 24.

When you are finished the installed stock rails should look like the ones in image 24.



Image 24

Form and Install the Closure/Switch Point Rails

The four closure/switch point rails must be installed in numerical order as shown in Appendix Drawing 1 & 6.

Step 1

Starting with the #1 straight route closure rail, cut a length of rail about 1" longer than required.

Step 2

File the switch point on one end of the rail that you just cut. (Image 25)

If you are using the Fast Tracks PointForm tool, simply insert the rail into the end marked "Point" and file. See the "Using The Fast Tracks PointForm Tool" document for complete instructions.



Image 25

Step 3

Place the rail into the appropriate groove in the fixture ensuring that the switch point end is properly located against the left stock rail at the throwbar. (Arrow in image 26)

A line has been engraved onto the fixture where the wing rail is to be bent at the end of the closure rail. Using a scribe or marker carefully mark this location.

Image 26

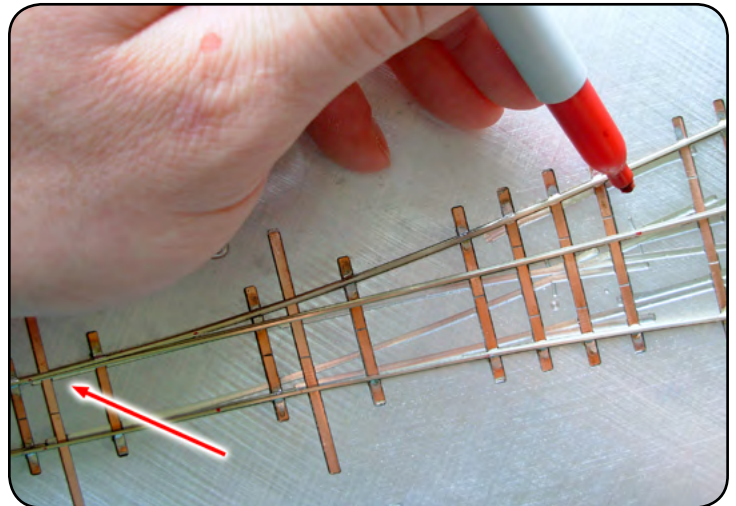

Step 4

Using rail nippers, or a triangle file, form a notch in the base of the rail at the location you marked in the previous step. (Image 27)

Removing this small piece of the base rail will aid in getting a good "kink" in the rail.

Image 27

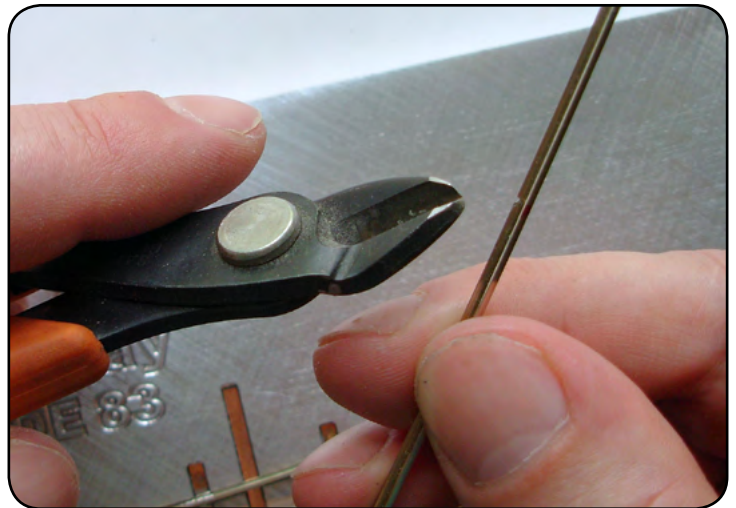

Step 5

Supporting the rail with your fingers at the notch formed in the previous step, carefully bend the wing rail by hand. (Image 28)

Image 28

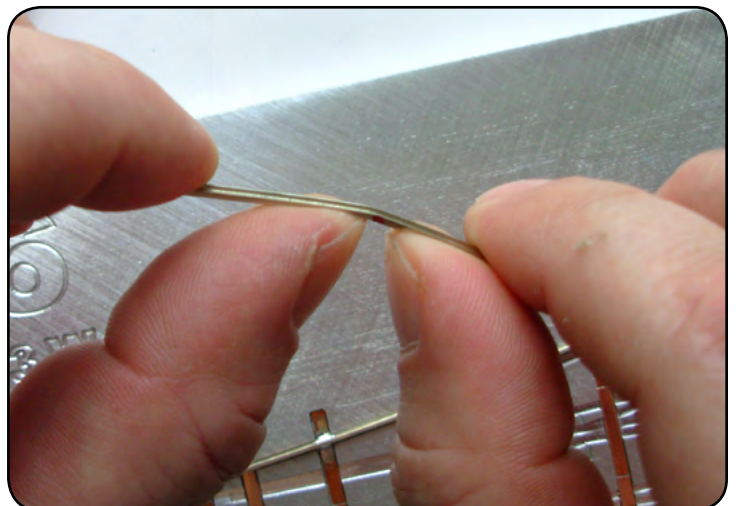

Step 6

Place the rail back into the fixture and adjust the bend as necessary.

Step 7

Using the fixture as a reference, mark the end of the wingrail. (Image 29)

Step 8

Cut the wingrail to length.

Step 9

A "flare" needs to be filed on the end of the wingrail to prevent the wheel flanges from 'picking' the end of the rail.

The flare is a compound angle formed by simultaneously filing an angle from the top and the side of the rail.

Image 30 shows a number of different views of this flare. The shaded areas have been filed. The flare is on the flange side of the rail.

Image 29

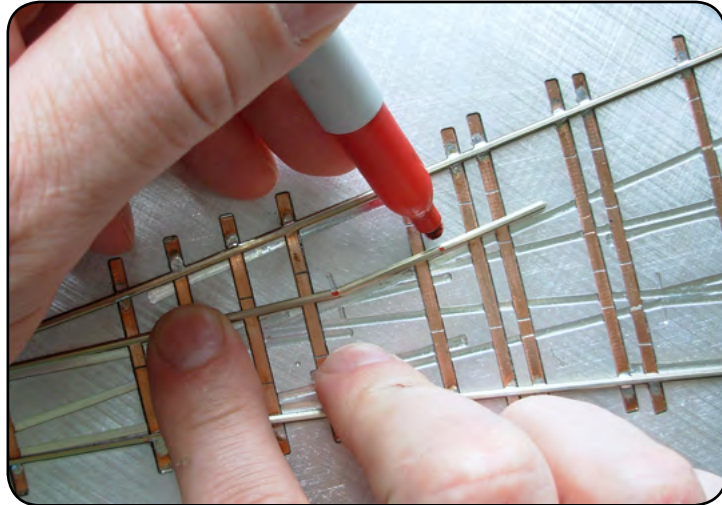
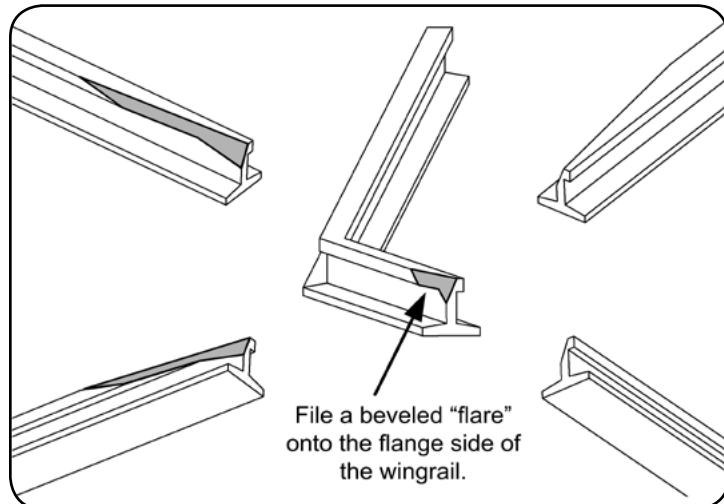

Image 30



Step 10

Confirm that the closure rail fits accurately in the appropriate groove in the fixture. (Image 31)

Image 31

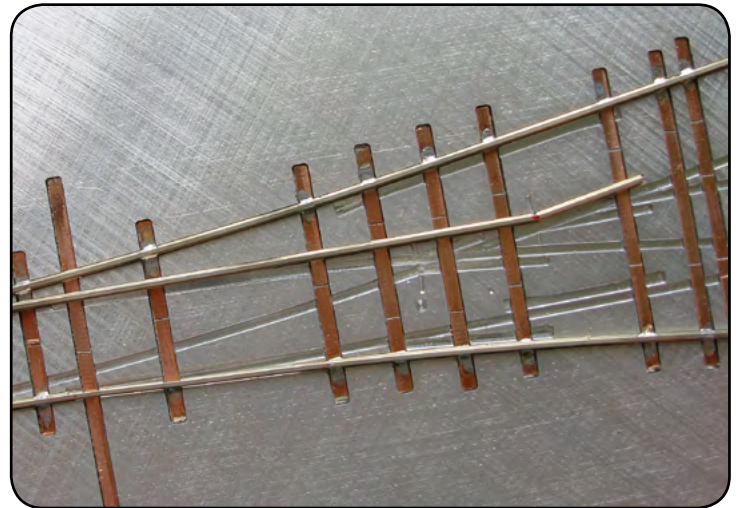

Step 11

The #1 straight route closure rail needs to have the base removed where the right diverging route closure rail switchpoints fit against it. This step only applies to the #1 straight route closure rail.

With the rail accurately placed in the fixture, mark the location where the base is to be removed as shown in image 32.

Image 32

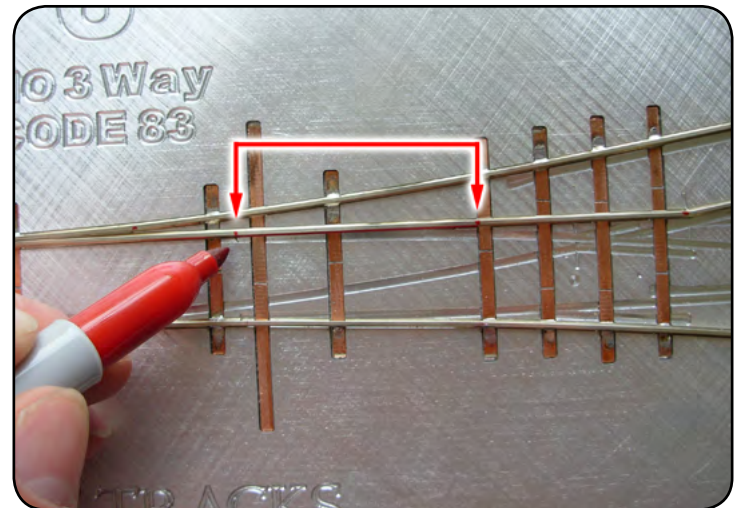

Step 12

Remove the base using the same methods you used for the stock rails. (Image 33)

Image 33

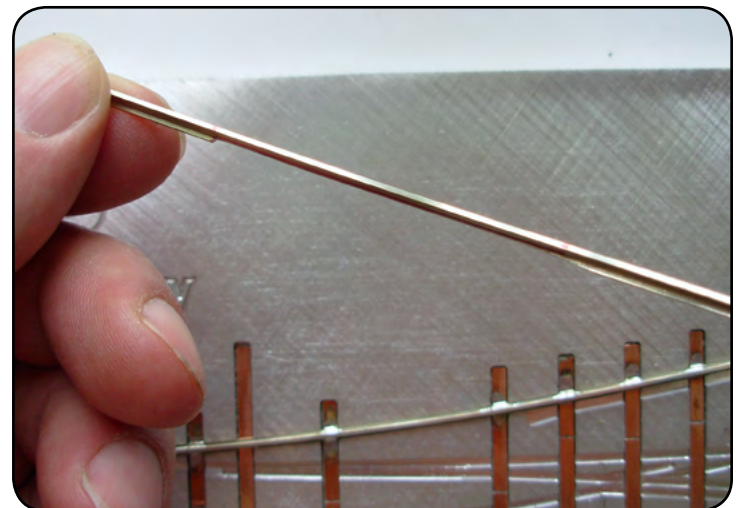

Step 13

Confirm the accuracy of the finished rail and solder it into place. Apply solder at the locations marked in image 35. **Do not** solder the switch point to the throwbar just yet!

Step 14

Repeat steps 1 to 10 to form and place the #2 straight route closure rail. (Image 36)

Image 34

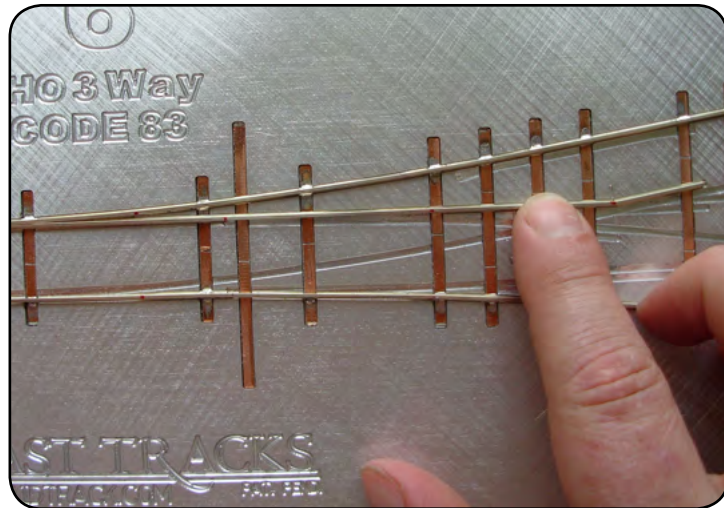

Image 35

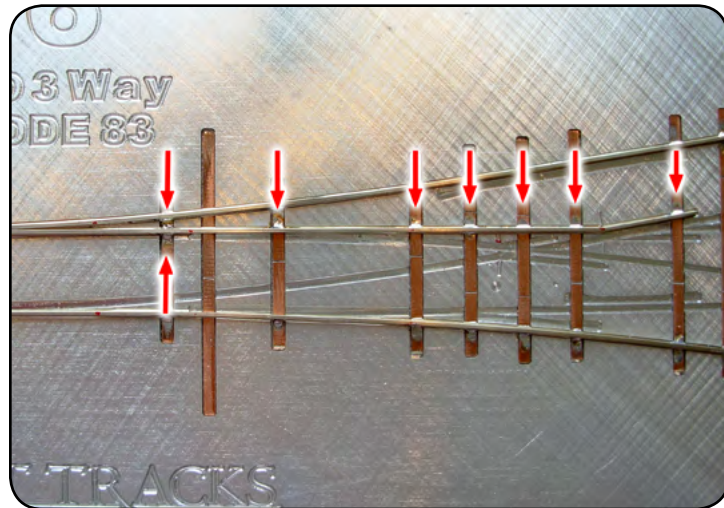
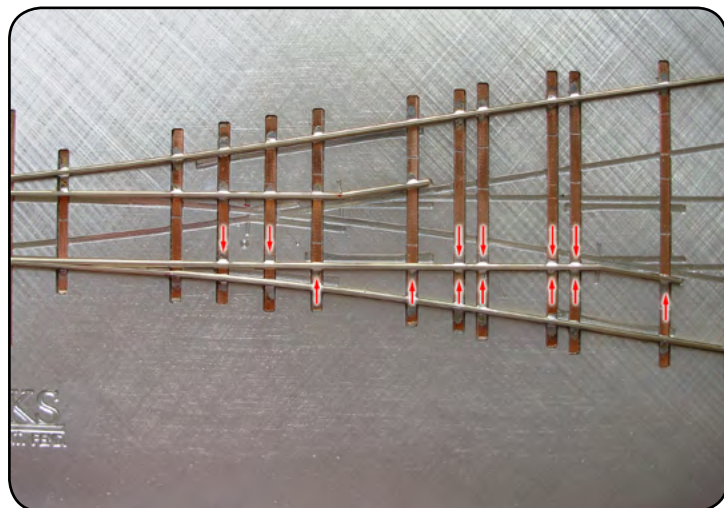

Image 36



Step 15

Form a switchpoint from a length of rail for the right diverging route closure rail #3. It is important to pre-curve this rail slightly so it closely matches the groove in the fixture as shown in image 37.

When correctly shaped it should fit into the groove without distortion, this way when the turnout is removed from the fixture the rail will not go out of shape possible creating an area of the turnout that is out of gauge.

Image 37

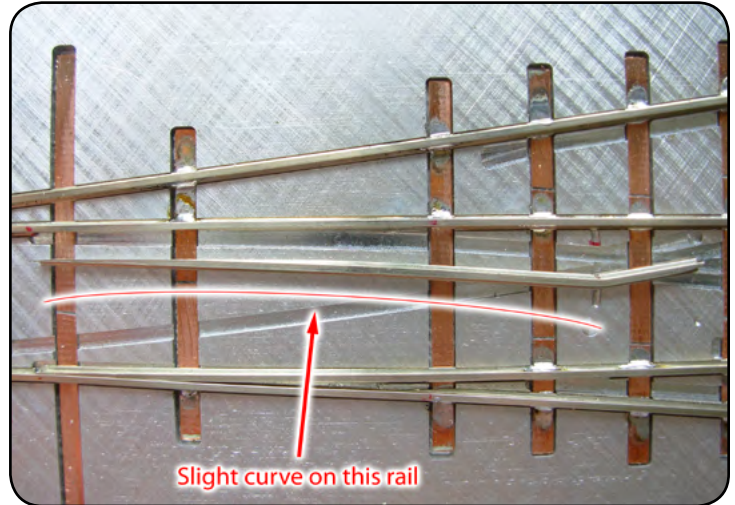

Step 16

Carefully study image 38 and you will notice that both sides of the wing rail of closure rail #3 have been filed with a taper. The taper on the top side of the rail is necessary in order to provide clearance for the wheel flanges on the gauge side of the straight route rail. While the taper on the bottom side is the flare that we created in step 9.

Image 38

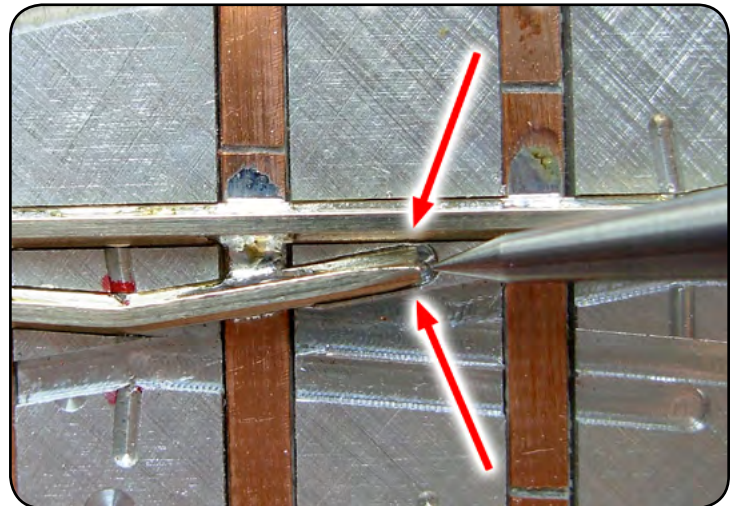

Step 17

Solder the #3 closure rail to the PC Board ties at the locations shown in image 39.

Image 39

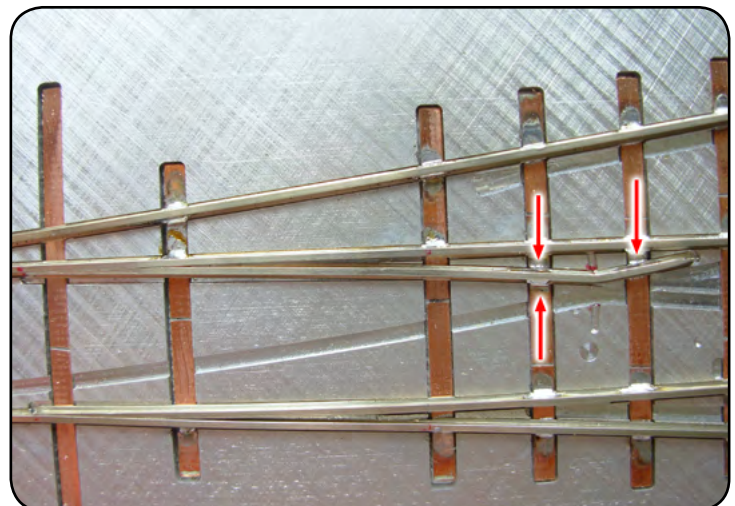

Step 18

Form and install the #4 left diverging route closure rail using the techniques described in steps 1 to 10 and solder it to the PC Board ties at the locations shown in Image 40.

Image 40

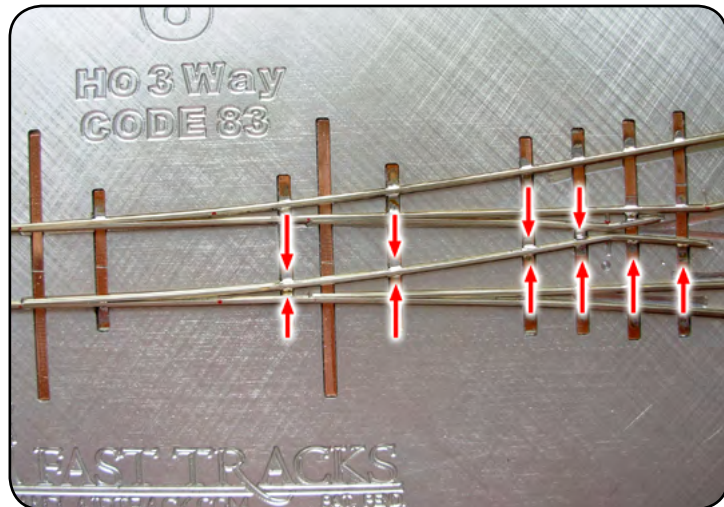

Install The Pre-Built Frogs

Some additional work needs to be done on the sub-frog before it can be installed.

Step 1

Place the sub frog into the fixture and using the marks engraved into the fixture mark the two locations where the wing rail bends need to be formed. (Image 41)

Image 41



Step 2

Using rail nippers or a triangle file cut a notches at these locations. (Image 42)

Step 3

Using the fixture grooves as a guide, bend the rail at these locations in the same manner as the previous wing rails.

Image 42

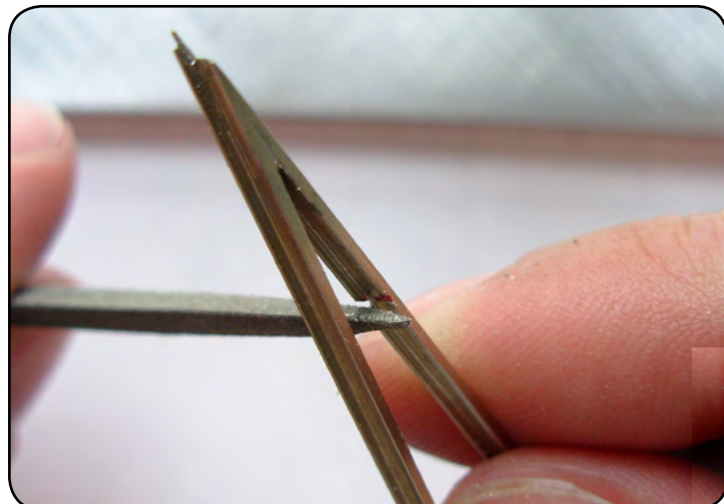

Step 4

Return the frog to the fixture and mark the length of the wing rails using the grooves in the fixture as a guide. (Image 43)

Image 43



Step 5

Cut the wing rails to length.

Step 6

Form the wing rail flairs using the same method described in step 9 of the closure/switch point section.

Step 7

Return the sub frog assembly into the fixture and adjust the wing rails as needed.

Image 44

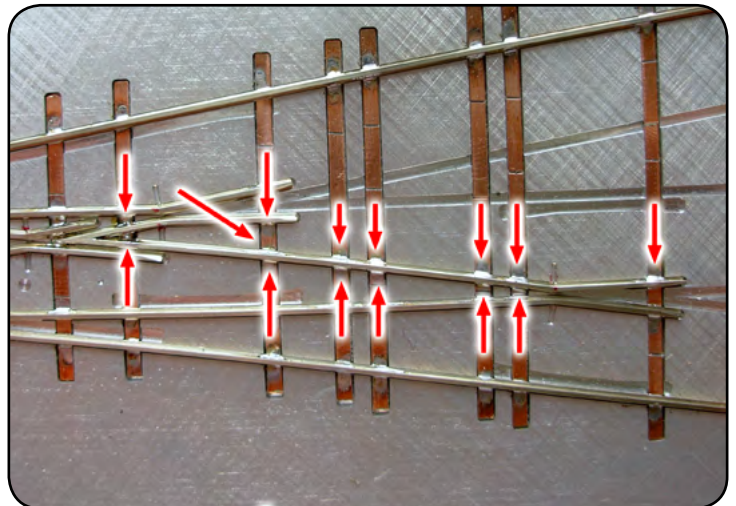

Step 8

Solder the frog to the PC Board ties at the points shown in Image 44.

Step 9

Install and solder the remaining pre-formed frog points in place as shown in image 45.

Image 45

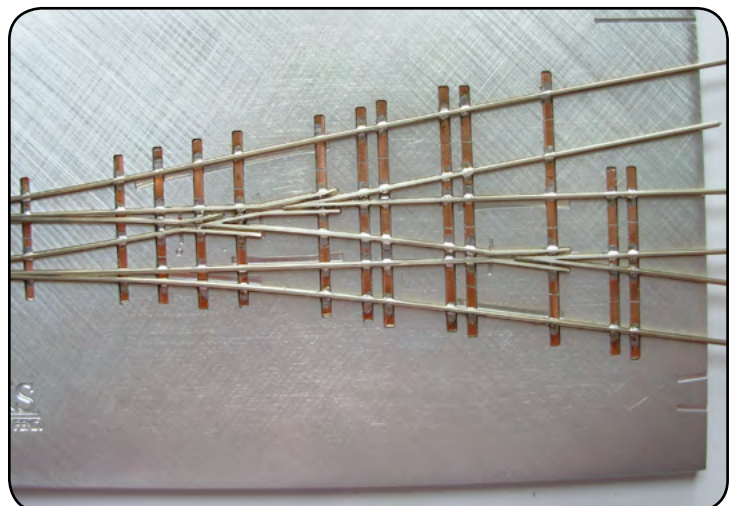

Install the Pre-Formed Guard Rails

Step 1

Install and solder all of the A & B guard rails that you formed earlier to the PC Board ties.

Step 2

The C guard rail only has a flare on one end and requires a bevel to be filed on the opposite end. (Image 46)

To build the C guard rail start by cutting a piece of rail to length using the short guard rail forming groove. (Image 47)

Step 3

Bend a flare on the left end of the guard rail using the bending grooves. (Image 48)

Image 46

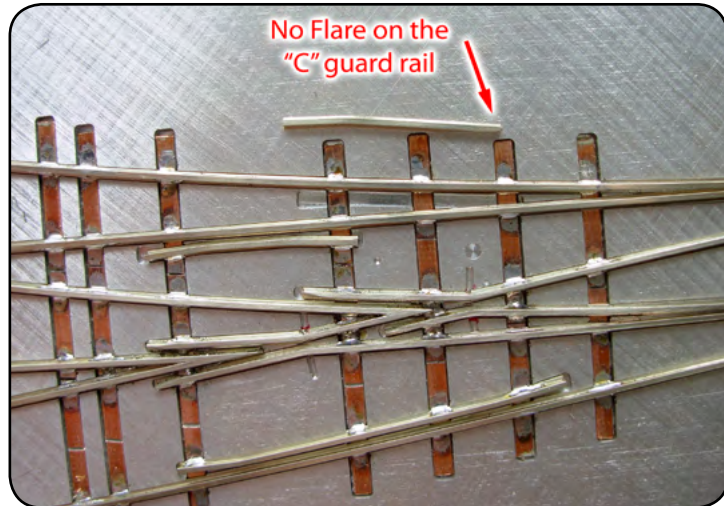

Image 47

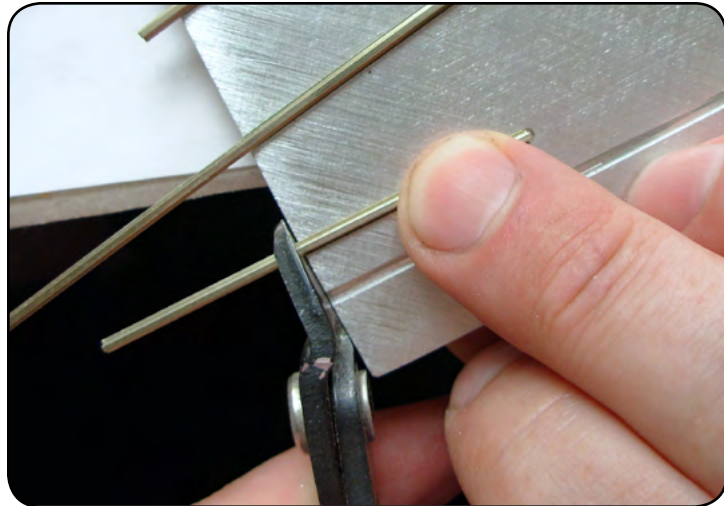
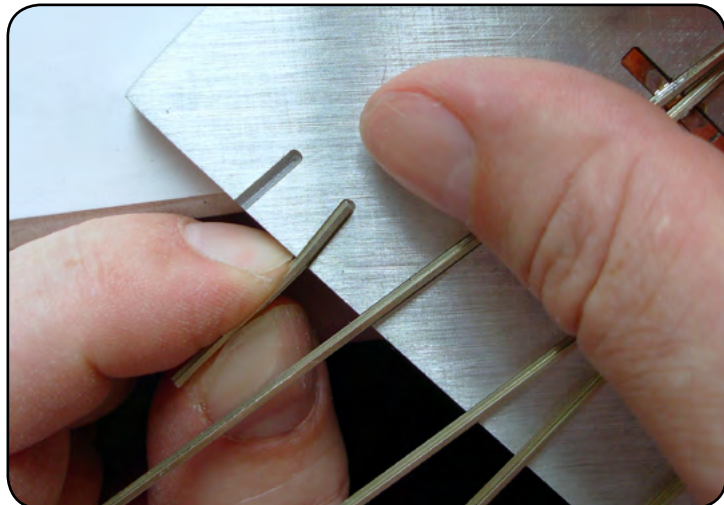

Image 48



Step 4

On the end opposite the flare, file a long bevel about 3/8" (10mm) long as shown in Image 49 and 50.

Step 5

Confirm the fit of the rail in the fixture. Notice in image 51 that there is a slight clearance between the bases of the C guard rail and the #2 straight route closure rail. Ensure that there is clearance and that the base of one rail is not sitting on top of the other.

Image 49

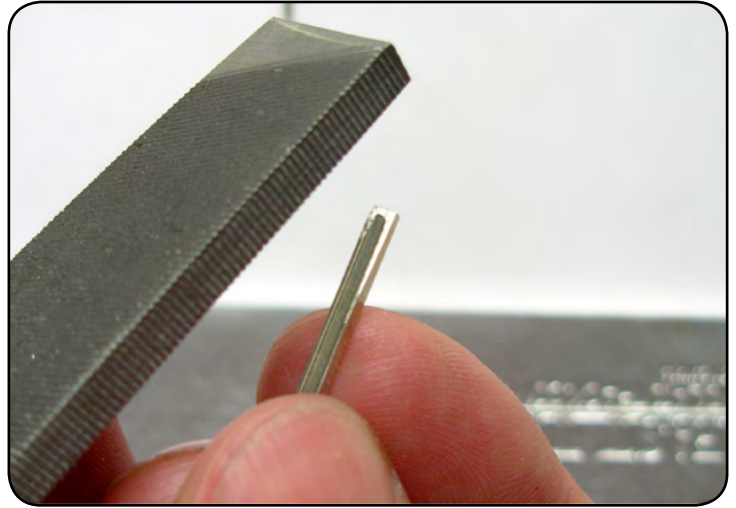

Image 50

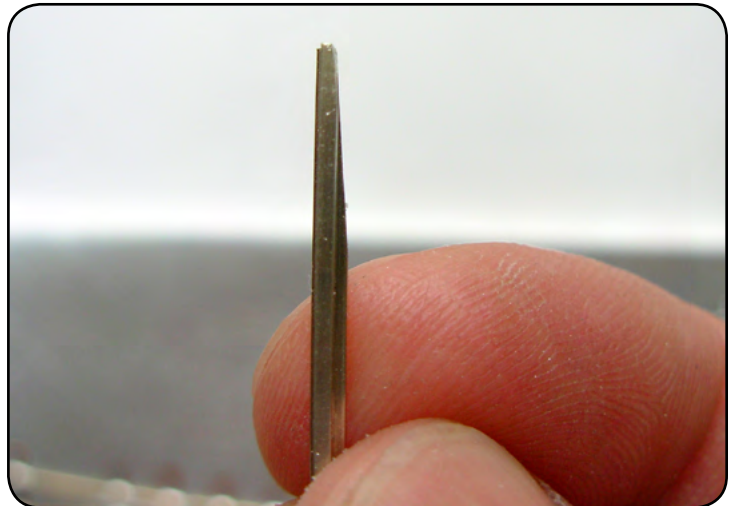
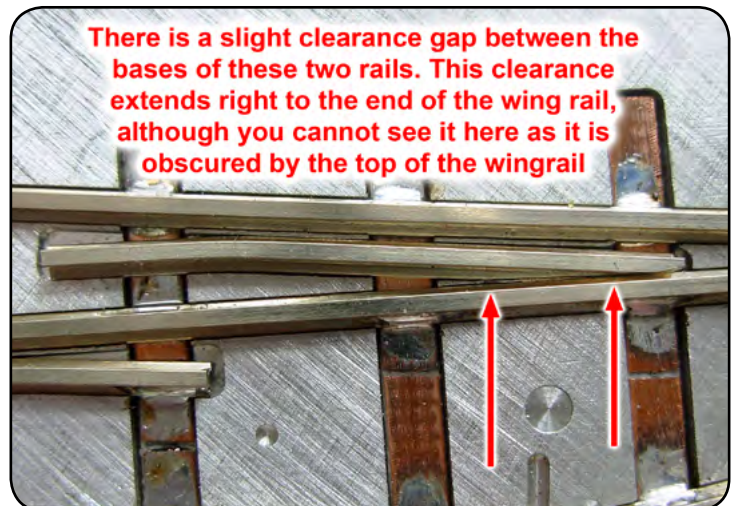

Image 51



Step 6

Solder the wingrail in place. The solder will need to be applied to the top of the rails to securely join the guard rail to the rest of the turnout as there isn't enough clearance to solder at the base of the rail. (Image 52)

Image 52

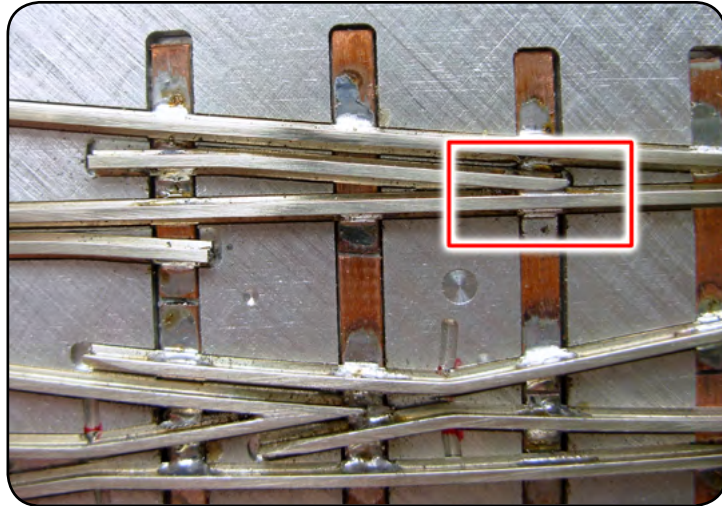

Step 7

Clean any excess solder from the top of the rail with a fine emery board using care to not scratch the rail.

Re-Enforce the Frog Points

Step 1

Gently remove the turnout from the fixture. It may be a bit tight and care must be taken not to deform the turnout by prying it out of the fixture with too much force. If you are finding it difficult to remove, try gently lifting the ends of the rails that are protruding from the fixture being careful not to bend any of the rails.

Image 53

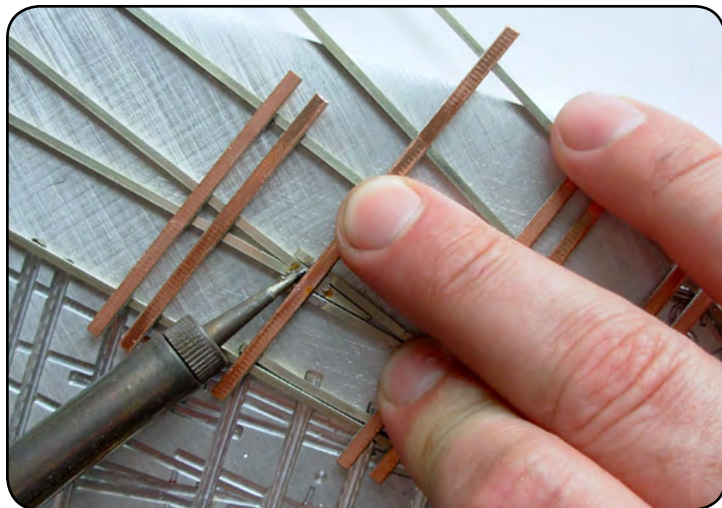

Step 2

Turn the turnout over and re-enforce all of the frog points by applying solder to the bottom of the frogs. (Image 53) Apply a small amount of flux to the base of the rail and apply heat to the rail at the PC board tie next to the frog point. The solder will wick between the rail and the PC board ties forming a solid bond between the frog points and the tie.

This step is best done with the turnout placed upside down on top of the fixture as the fixture will act as a heatsink and the flat surface will keep the rails on an even plane while soldering.

Cut Off the Switch Points

Image 54

The length of the switch point rail in a 3-Way turnout is very short and will not flex freely like a standard turnout and needs to be hinged. This is easily accomplished by cutting the switchpoint from the closure rail and soldering on a standard rail joiner in place to act as a hinge.

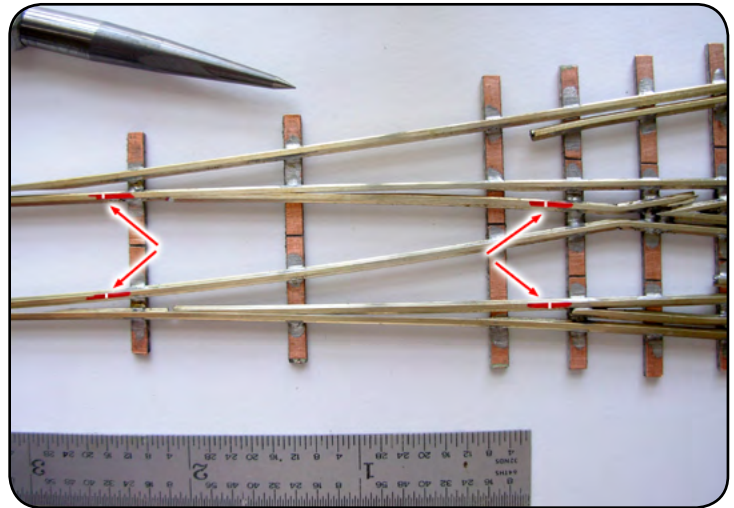

Step 1

Mark the top of the rail and scribe a guideline where the rail is to be cut. The cut should be about 3/16" (5mm) below the PC board tie. (Image 54)

Image 55

Step 2

Clamp the trackwork into a vice on the end of the ties below the area where this cut is to be made. (Image 55)

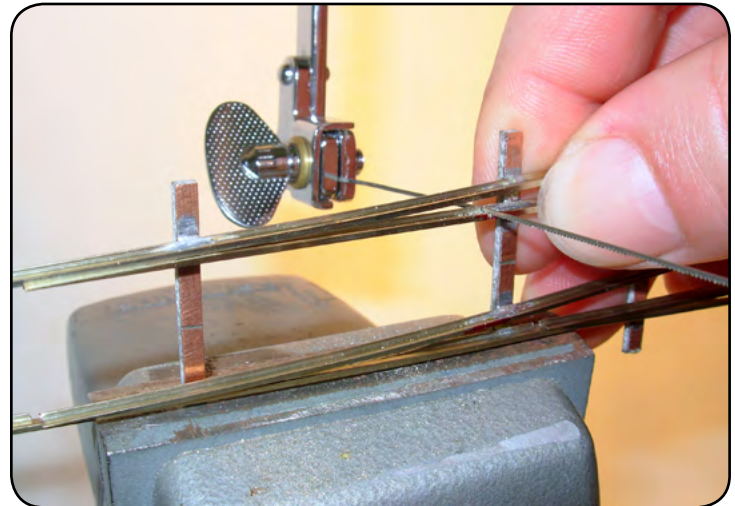

Step 3

Using a jewelers saw, carefully cut the switch point from the closure rail. (Image 55) Once cut from the trackwork, place the loose point in the corresponding position in the assembly fixture to keep from mixing them up.

Image 56

Step 4

Repeat this process for all of the remaining switch points.

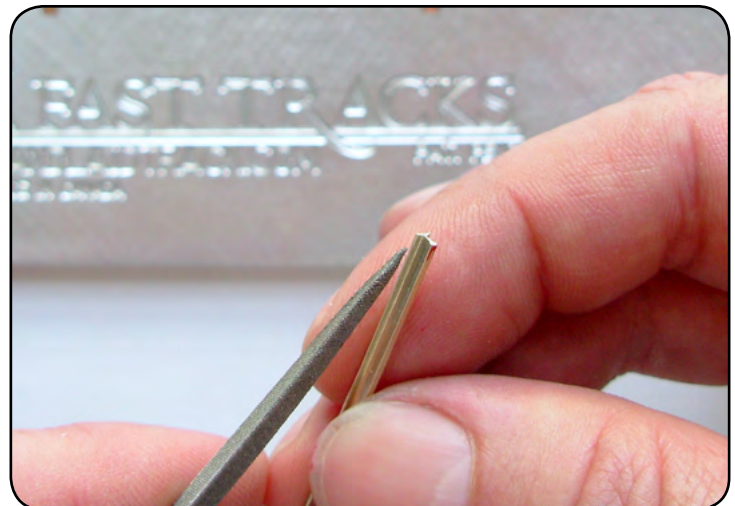

Step 5

Inspect the points and the closure rail for burrs and remove with a small file if necessary.

(Image 56)

Form and Install the Rail Joiner Hinges

Image 57

Step 1

At the hinge end of each switch point file a notch on each side of the base of the rail. A small triangle file works well for this. (Image 57) The notches should be approximately 1/16" (2mm) from the end. (Image 58)

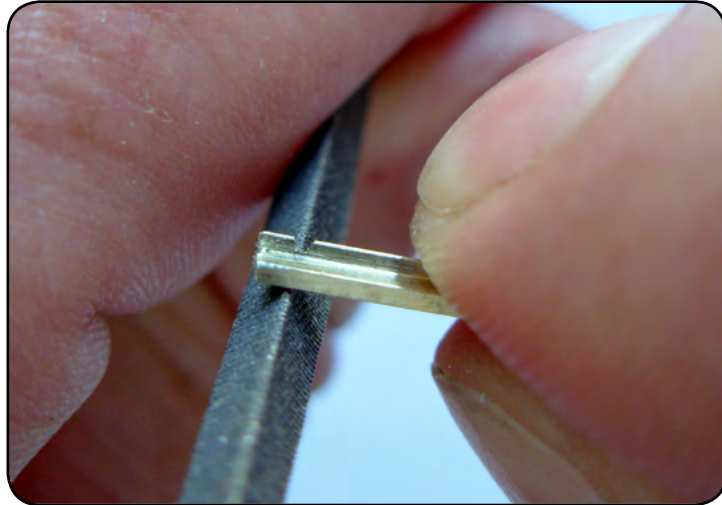

Step 2

Slip a rail joiner onto this end of the switch point and using rail cutters gently squeeze the joiner into the notches formed in the previous step. (Image 59)

Image 58

If you mark the location of the notches on the head of the rail, it will make it easier to know where to crimp the joiner.

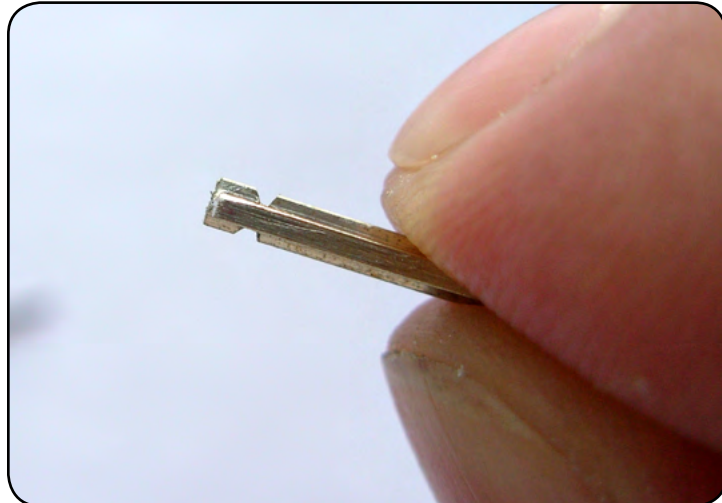

Image 59



Step 3

Using a rotary tool cut the end of the rail joiner off leaving approximately 1/8" (3mm) protruding from the end of the point to act as the hinge. (Image 61)

Step 4

Slide the switchpoint/joiner assembly back onto the rail at the same location where it was previously cut off.

Step 5

Apply a small amount of flux and solder the rail joiner to the fixed rail. (Not the switchpoint) Be careful not to solder the end of the point or it will not hinge freely. (Image 62)

Step 6

Once soldered, confirm that the rail will pivot freely. If not, flex the point back and forth to free up the movement.

Step 7

Repeat steps 1 to 6 for the remaining switch points and hinges.

Image 60

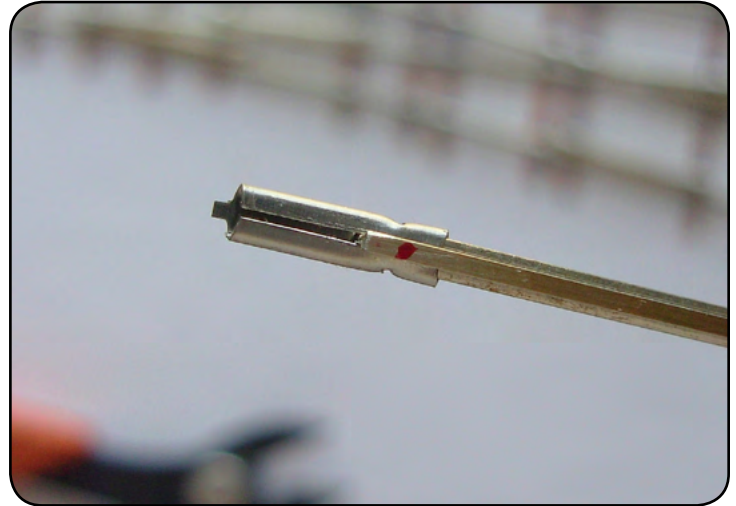

Image 61

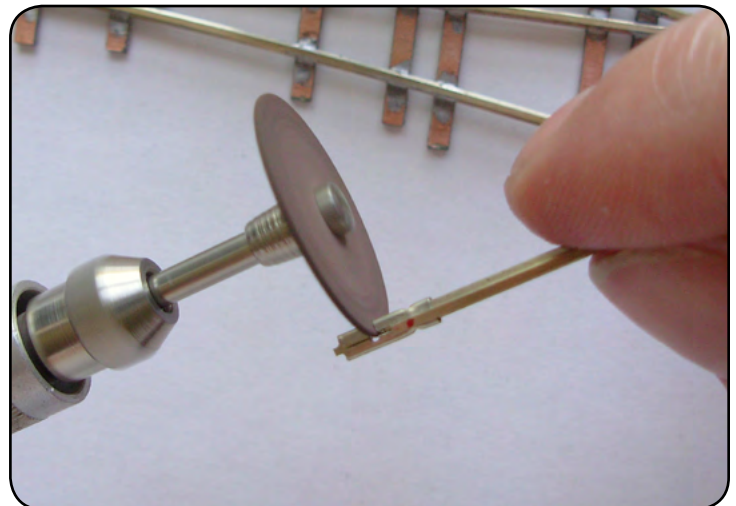
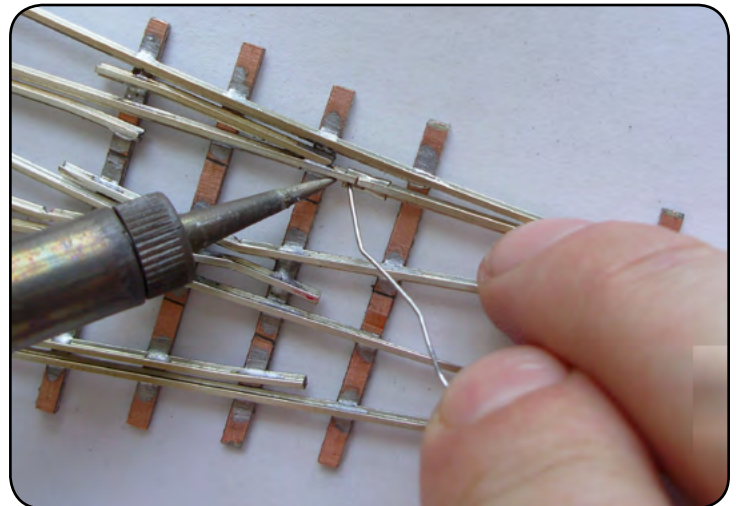

Image 62



Solder the Switch Points to the Throw Bar

Step 1

Start by taping the turnout and throwbar tie to a flat surface. This will make it easier to solder the switchpoints to the throwbar.

Image 63

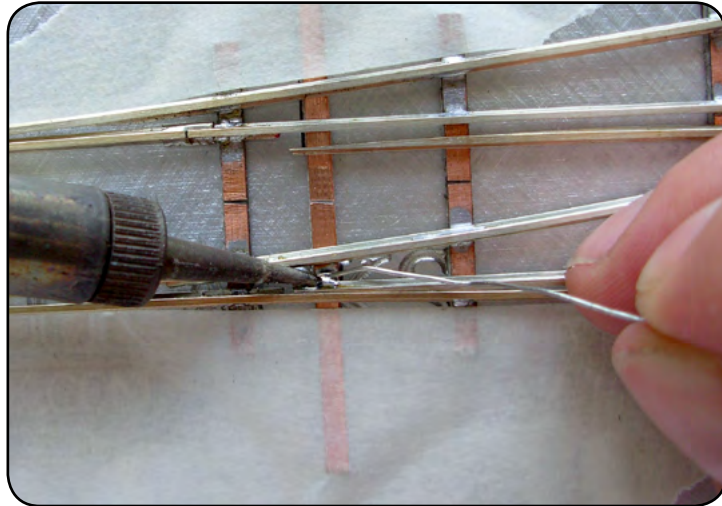

Step 2

The upper set of switchpoints (nearest to the frog points) should be soldered in place first. Starting with the straight route switch point apply a small amount of flux and carefully solder it to the throwbar PC board tie. (Image 63) Do not use an excessive amount of solder on this joint as it might interfere with the stock rail adjacent to the point.

Image 64

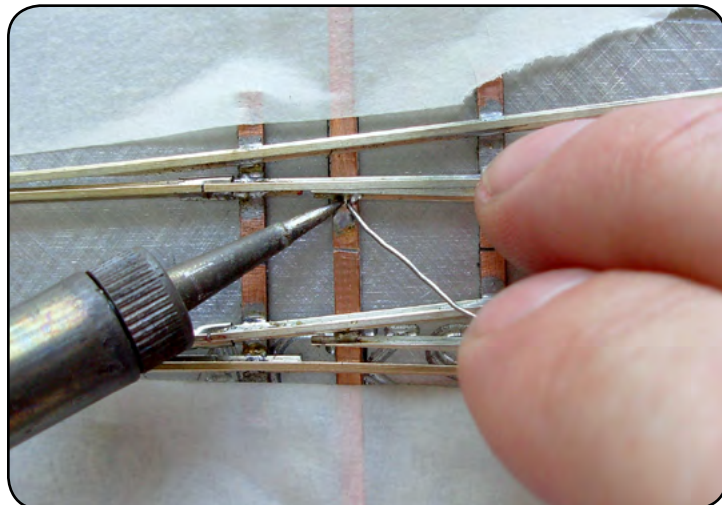

Step 3

Open the straight route point as far as possible to allow for the proper clearance at the switch point. If the solder joint interferes with the rail it may be necessary to remove some with a file. Ensure the throwbar tie stays as square as possible with the straight route. (Image 64)

Step 4

Repeat these steps for the lower set of switch points. Space the point gap by using a PC Board tie between the switch point and stock rail. (Image 65)

Once complete the points should pivot freely and the switch points should sit tight against either stock rail. (Image 66)

Image 65



Image 66

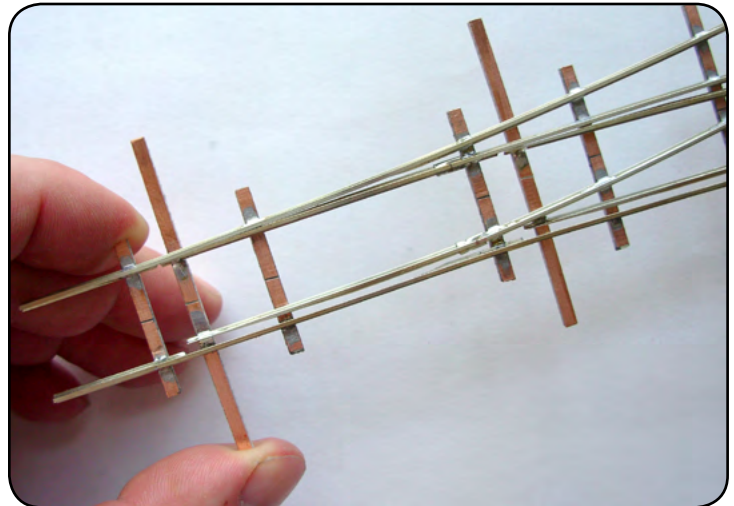

Cut the Frog Isolation Gaps

Isolation gaps need to be cut into the rails to isolate the frogs for DC and DCC operation. Refer to Appendix Drawing 1 to determine where the gaps need to be cut in the rails.

Step 1

Clamp the turnout into a vise onto the end of the ties. (Image 67)

Image 67



Step 2

Using a jeweler's saw carefully cut the gaps shown in image 67.

Step 3

Cutting the gaps can sometimes leave a small burr on the bottom of the rail which can cause a short. Be sure that the gaps are cut clean through by filing the bottom of the turnout with a triangle file. (Image 68)

Image 68

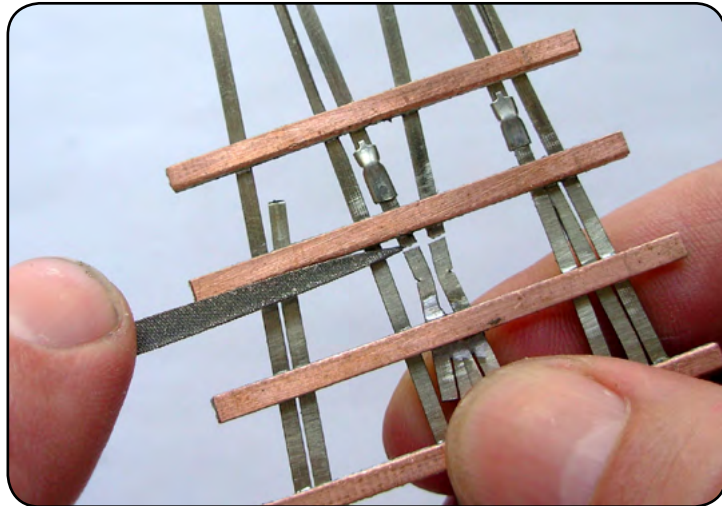

Step 4

Until the turnout is mounted onto the ties the rails at the frog end of the turnout will be fragile, so be sure to handle the finished assembly with care.

Thoroughly Clean the Completed Turnout Skeleton

Once you have completed soldering the turnout, you need to thoroughly clean it to be sure to remove all traces of soldering flux residue. This step is critical to ensure the trackwork does not corrode.

Image 69

Step 1

Scrubbing the turnout with a stiff wire brush is the most effective way to clean the turnout. Scrubbing the top of the ties and solder joints will remove all traces of flux residue and help smooth out the solder. (Image 69)

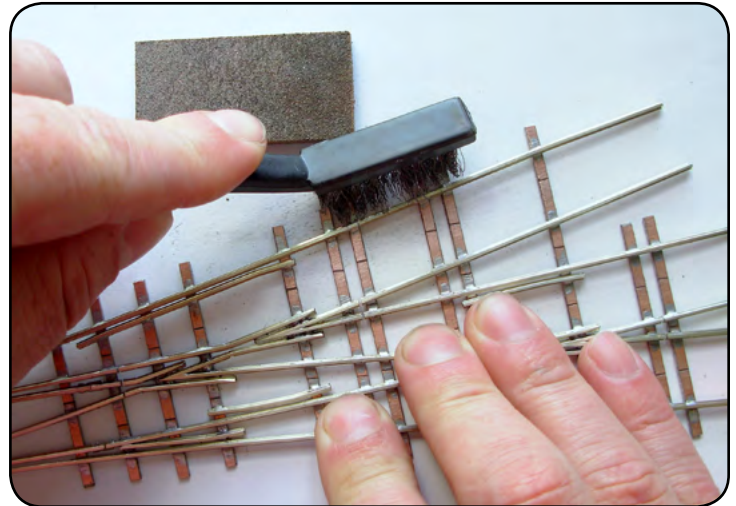

Step 2

Using a rail cleaner, polish the top of the rails. (Image 70)

Image 70

Step 3

After scrubbing the turnout and polishing the top of the rails, wash the turnout with soapy water to remove all traces of dust and dirt from the rail and ties. (Image 71) Pat dry or use compressed air to remove moisture.

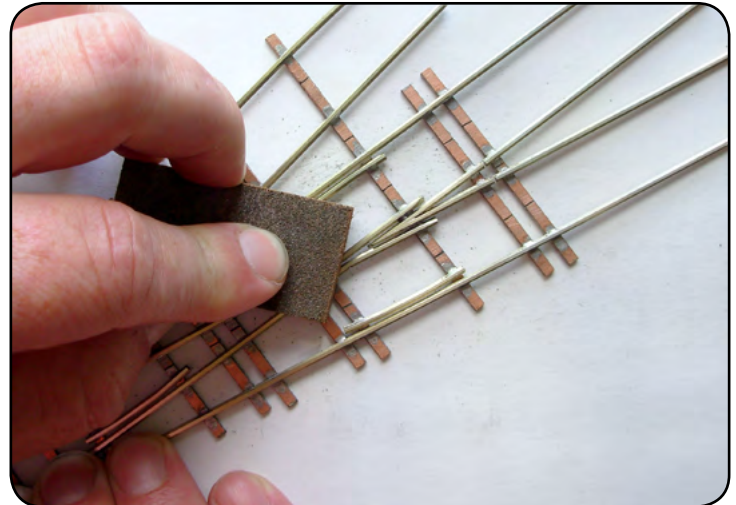

Be certain to thoroughly scrub and clean all areas of the turnout where soldering has taken place, including the bottom of the frogs where they were re-enforced.

Image 71

A careful job, combined with painting the completed turnout will prevent corrosion that can be caused from the solder flux and oils left behind from fingerprints.

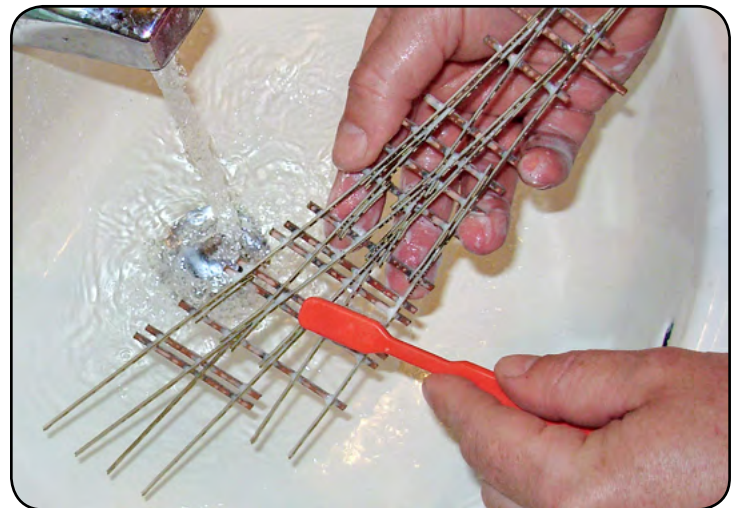

Glue QuickSticks Laser Cut Ties to the Completed Trackwork (Optional)

The optional QuickSticks laser cut ties are designed to be glued to the completed turnout using Pliobond - a contact type of adhesive. This type of adhesive works like contact cement and must be applied to BOTH surfaces being joined.

Step 1

Apply a bead of Pliobond adhesive along the bottom of the rail. (Image 72) Do not apply any adhesive to any parts that move.

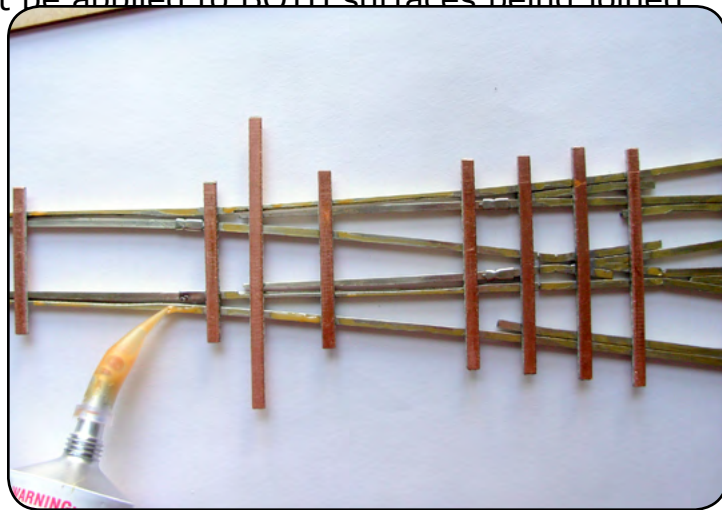

Step 2

Apply a bead of Pliobond to the webs of the QuickSticks. (Image 73) Lines are engraved onto the tops of the ties that show where to apply the adhesive. Apply adhesive to these areas only.

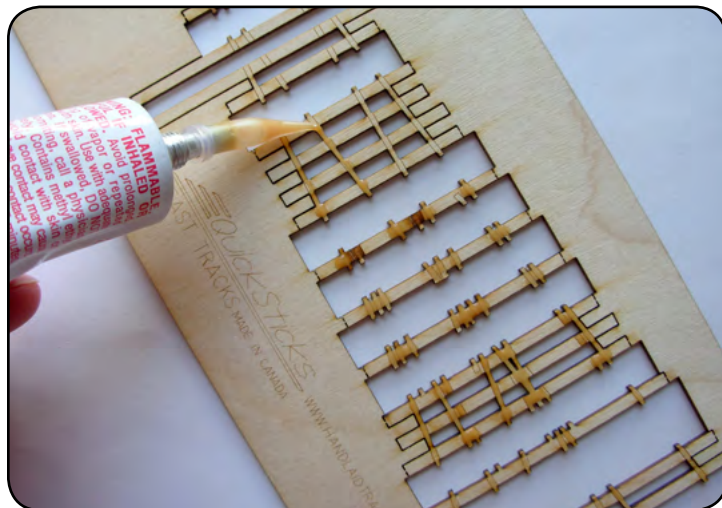

Step 3

Wait about 2-3 minutes for the liquid in the Pliobond to evaporate. This is required for the adhesive to work properly.

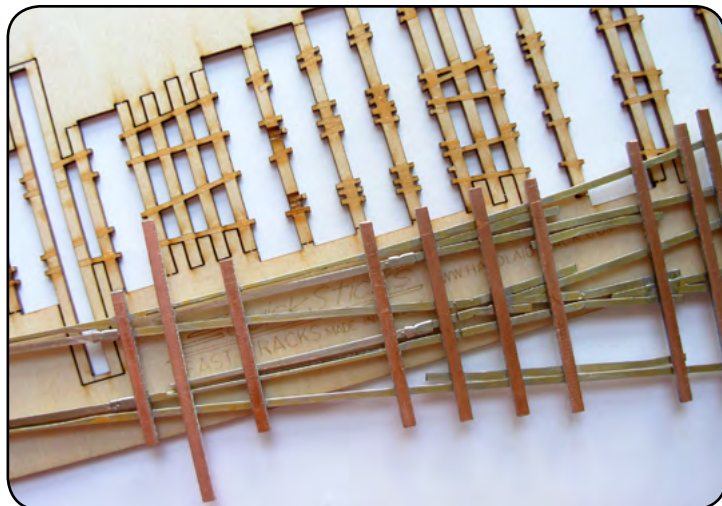

Step 5

Once the Pliobond has dried to the touch but is still a bit tacky, carefully lay the trackwork onto the ties using the throw bars to confirm alignment. (Image 75) Care must be taken here as it will be difficult to adjust positioning once the two surfaces of adhesive have made contact.

Image 75

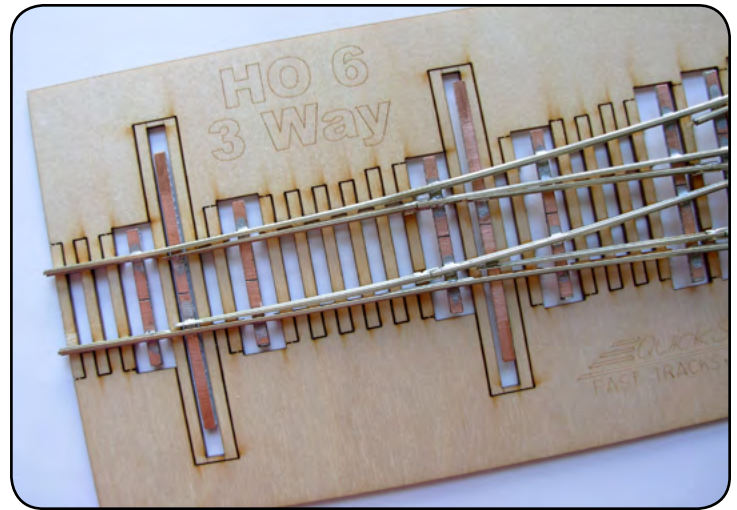

Step 6

Press the trackwork firmly into place on top of the QuickSticks.

Step 7

The curing process can be accelerated and improved with the application of heat. Using a soldering iron apply heat to the base of the rail for about 2 seconds to speed the curing process of the adhesive. (Image 76) Slowly work along all the rail in the turnout with the iron, heating the base to cure the adhesive. This will result in a very strong bond that will last the lifetime of the trackwork. The adhesive properties of Pliobond actually strengthen with age.

Image 76

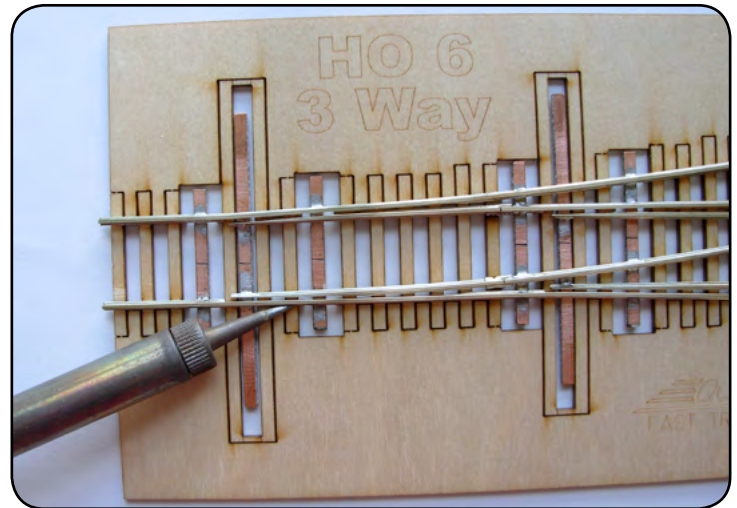

Step 8

The outside edges of the Quick-Sticks are designed to easily break away from the ties. Hold the rail firmly while flexing the wood, this will cause the tabs holding it in place to break. Carefully work your way down the length of the turnout to remove all the wood. (Images 77 to 79)

Image 77

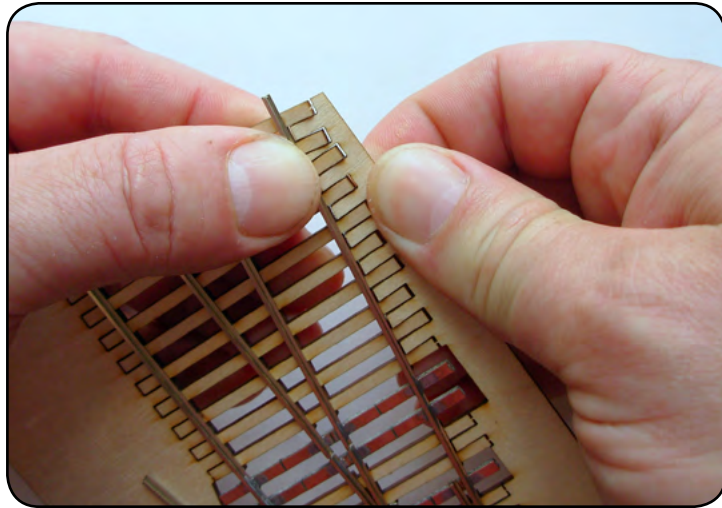

Image 78

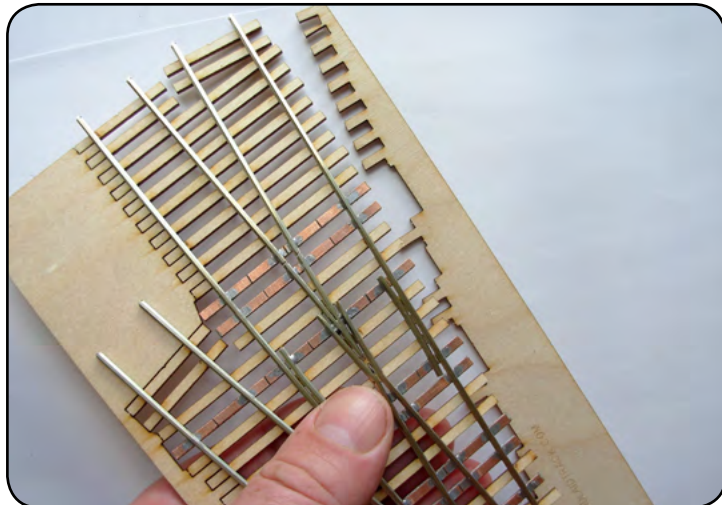
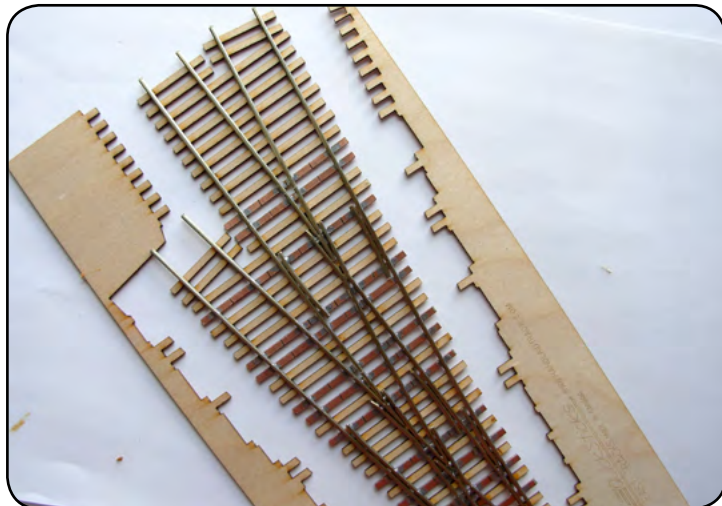

Image 79



You Are Finished!



Appendix Drawing 1

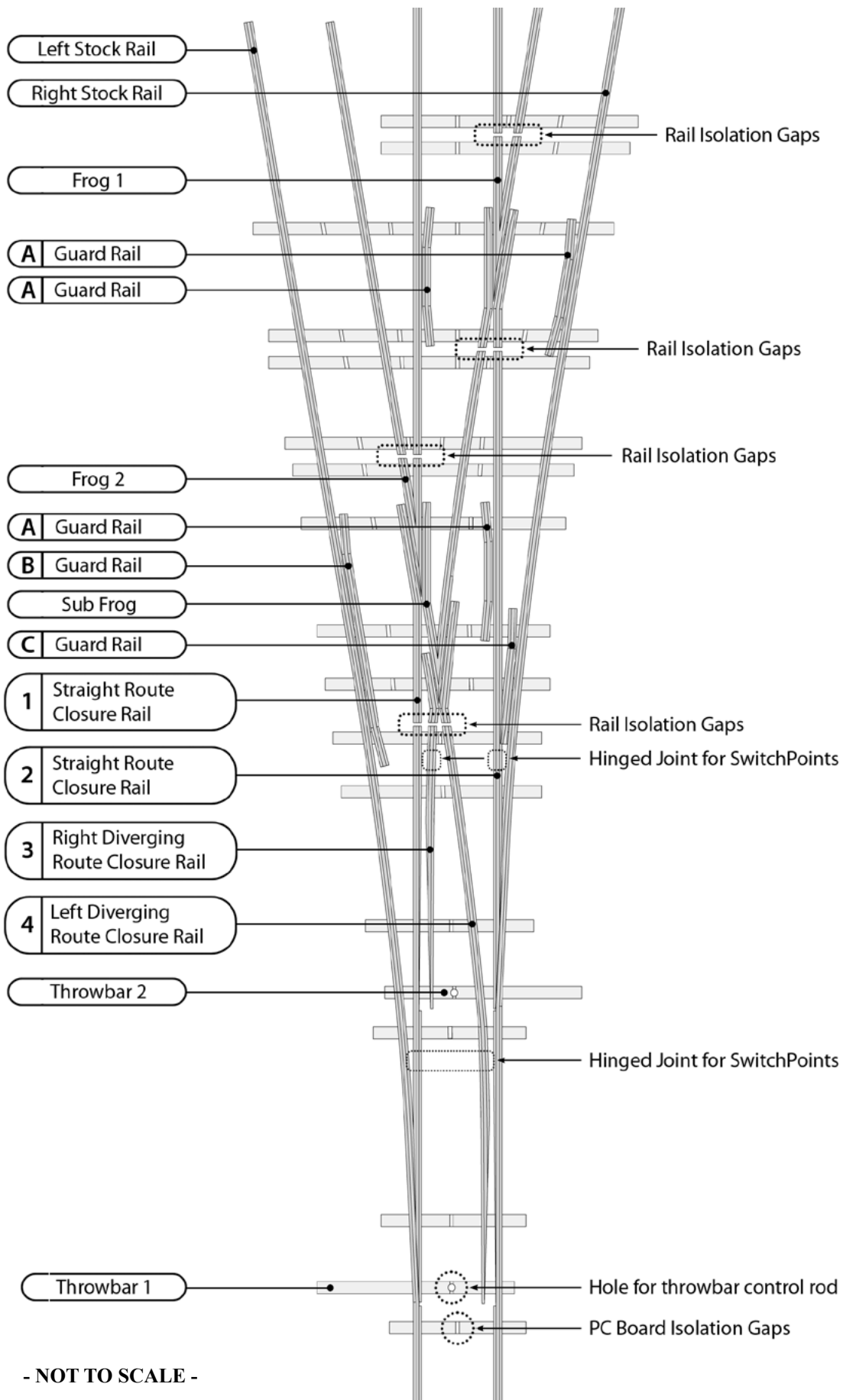

- NOT TO SCALE -

Appendix Drawing 2

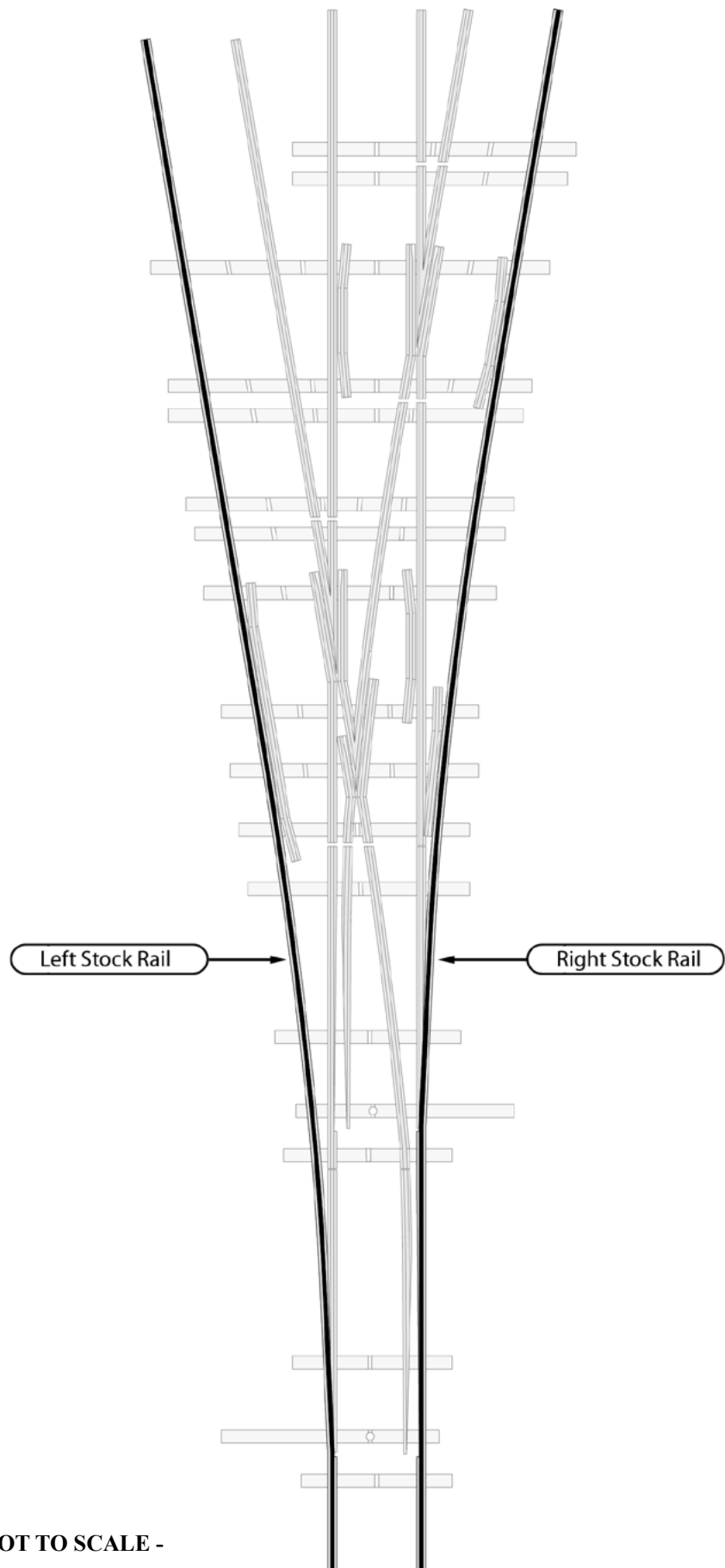

Appendix Drawing 3

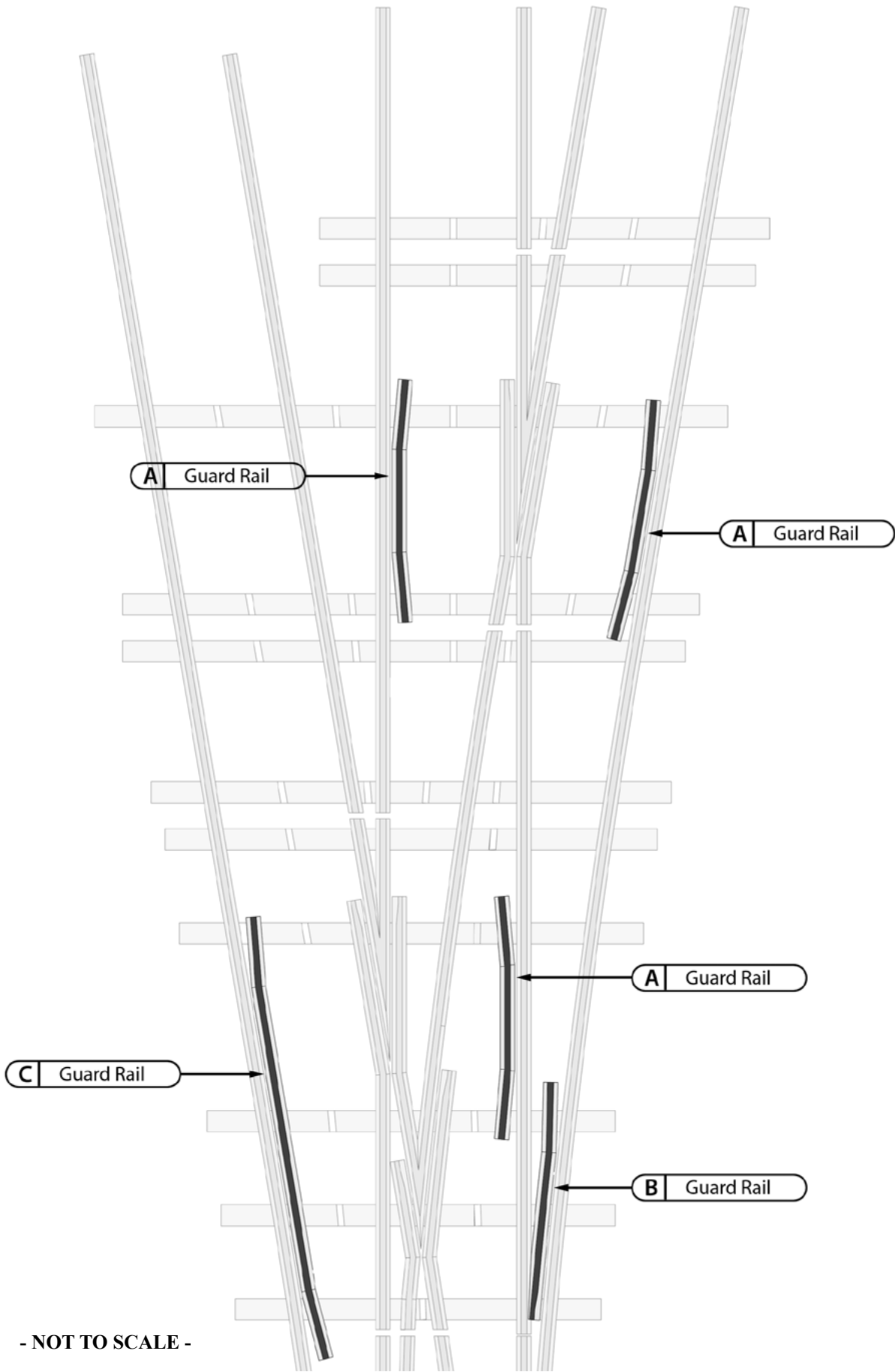

- NOT TO SCALE -

Appendix Drawing 4

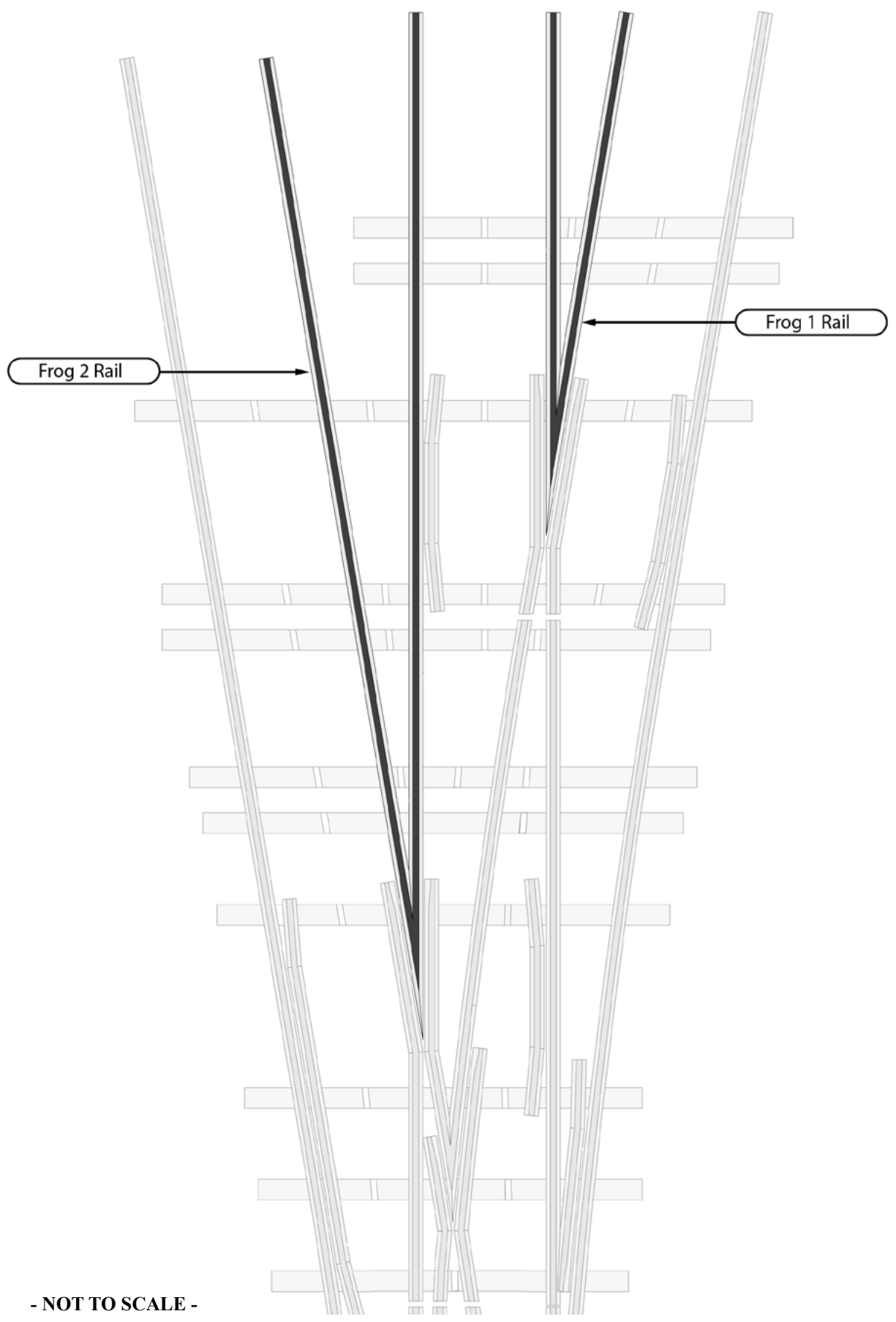

- NOT TO SCALE -

Appendix Drawing 5

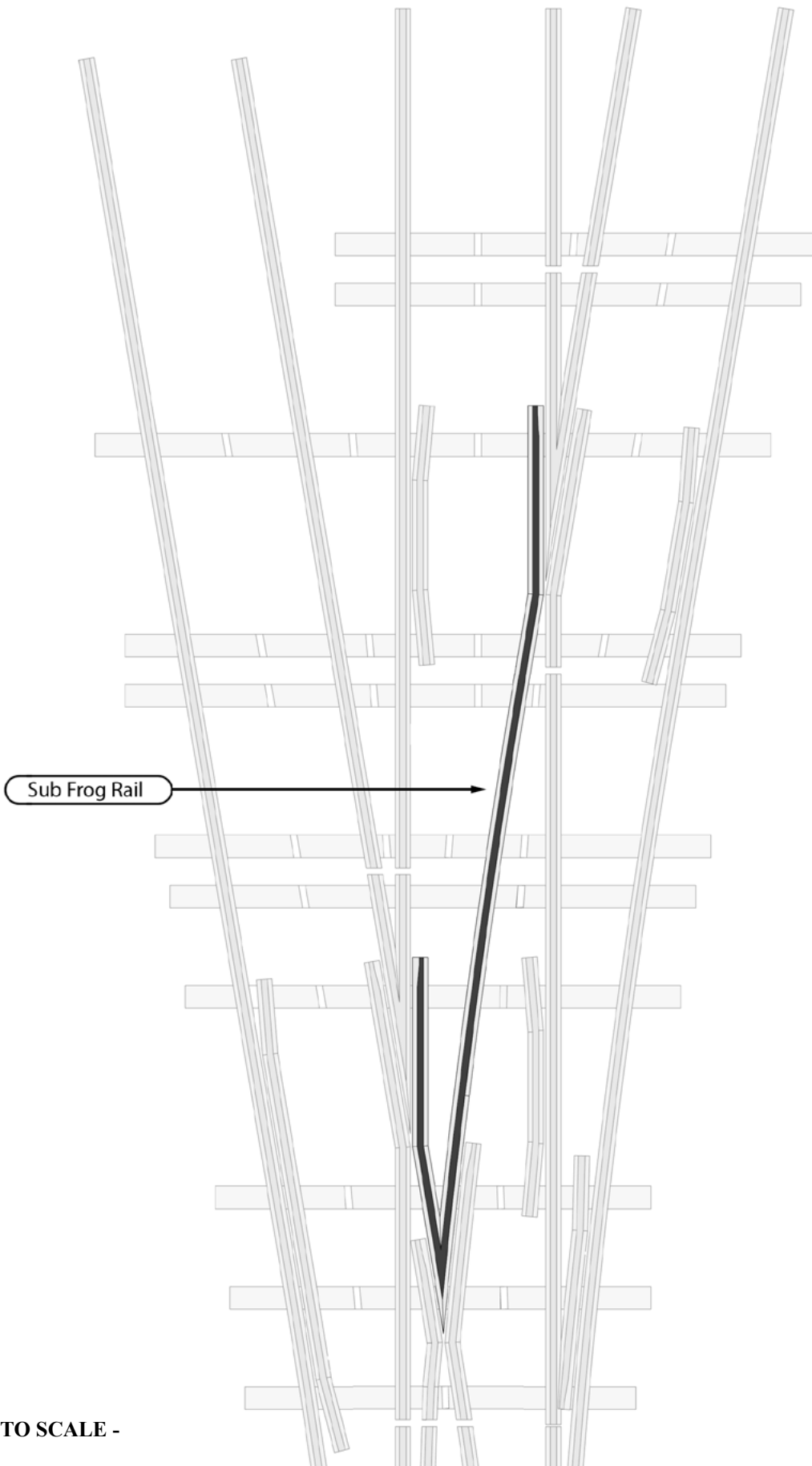

- NOT TO SCALE -

Appendix Drawing 6

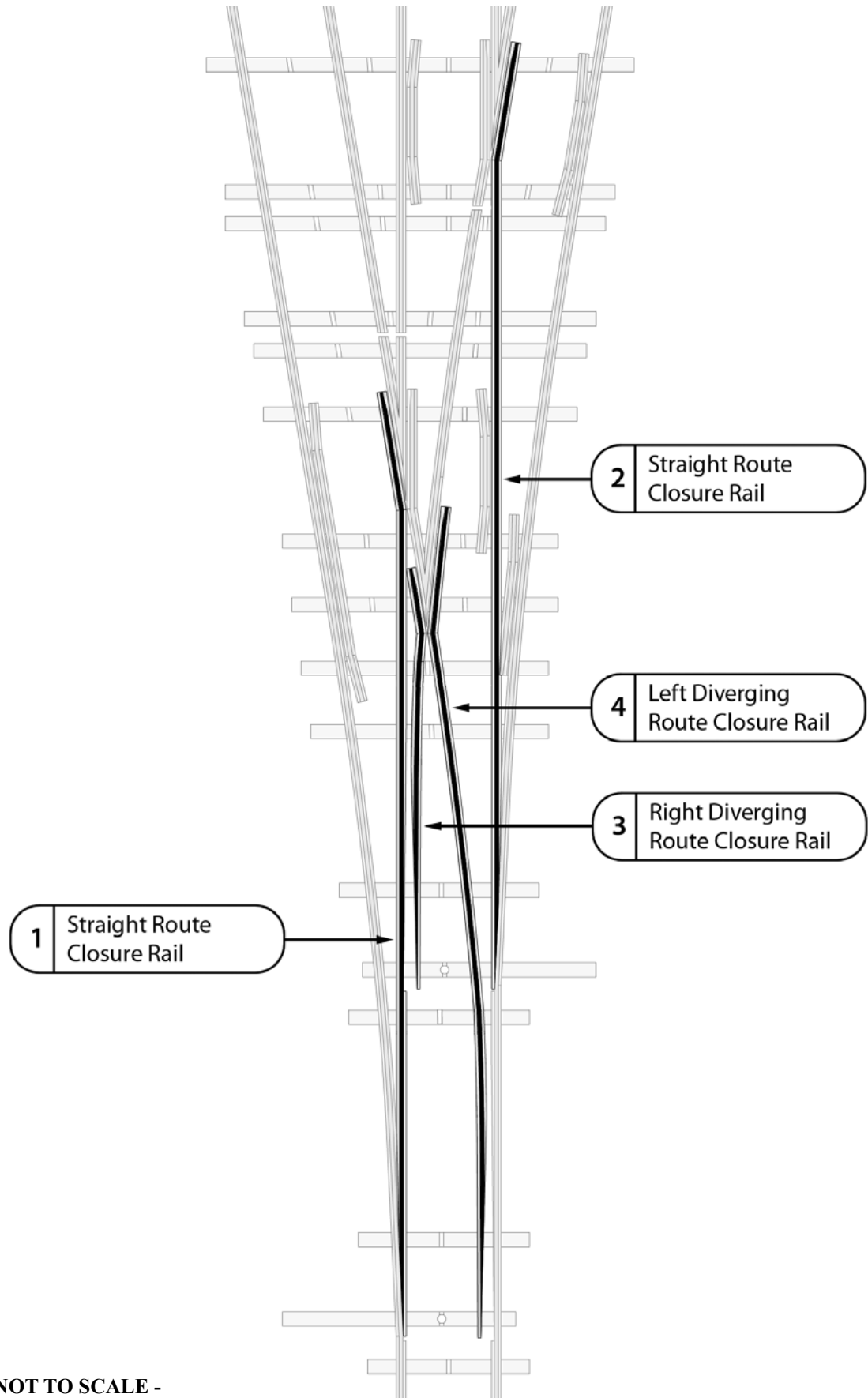

- NOT TO SCALE -